

MACHINERY

UPDATE

Issue 5, Volume XXXI, September/October 2020

The machinery only journal for processing & packaging | www.machineryupdate.co.uk

What price COVID-19?

The global pandemic has made everyone change their ways of working and in our special feature, we cover a raft of new products and services that PPMA members are now offering



INSIDE



NEWS

The BARA Webinar in July gathered a panel of experts from the food industry, machine suppliers, banking and education to discuss if C-19 will advance robot use

NEW MACHINERY

The HD-1500 mobile robot boasts a payload capacity of up to 1500 kg and has been designed for factories where autonomous materials handling has to cope with arduous tasks Find out more on page 22

INSTALLATIONS

A brand new yogurt making facility achieves greater consistency at speed



PLUS

Machinery Update's latest e-Bulletin includes a new way of marinating poultry in a quick and clean way www.machineryupdate.co.uk

PUBLISHED BY

PPMA GROUP OF ASSOCIATIONS

PPMA BARA UKIVA



Technology inspired by human talent

Cama Group is a leading supplier of advanced technology secondary packaging systems, continuously investing in innovative solutions.

www.camagroup.com - cama-UK@camagroup.com



cama
GROUP
Innovation meets Experience

Contents

7 NEWS

12 NEW MACHINERY

26 INSTALLATIONS

34 SPECIAL FEATURE COVID-19

PPMA member companies have changed their working practices in trying to sell, install, service or maintain their kit across the UK

64 SPECIAL FEATURE SUSTAINABILITY

While the coronavirus has delayed some sustainable packaging regulations, there is no doubt about the important role that equipment manufacturers can play in the sustainability debate



REGULAR FEATURES

72 LABELLING, CODING & MARKING

Martek Industries has installed three LCX high-resolution inkjet printers at a contract aerosol filler to improve efficiency and costs

74 COMPONENTS

uniVision parameterisable standard software for 2 and 3-dimensional image processing, has been updated by wenglor

78 REGULATIONS

Although current cyber security standards are lacking in some detail, they are at least a good first start to keep early IoT business adopters safe

80 WHO WHAT WHERE

People, events and company news

81 MACHINERY FINDER

Machinery and services

MACHINERY UPDATE

EDITOR:
Gail Hunt

PUBLISHING MANAGER:
Bill Lake

ADVERTISING SALES EXECUTIVE:
Robert Beswick

ARTWORK CONTRIBUTOR:
Barry Heath

HEAD OF PUBLISHING:
David Chadd

A PPMA PUBLICATION
PPMA Ltd
New Progress House,
34 Stafford Road,
Wallington,
SM6 9AA

TEL: +44 (0) 20 8773 8111

E-MAIL ADDRESSES:
publishing@ppma.co.uk
show@ppma.co.uk
technical@ppma.co.uk

WEBSITE:
www.machineryupdate.co.uk

APPLICATIONS FOR FREE COPIES of Machinery Update are considered from specifiers, managers and purchasers of processing and packaging machinery in the UK.

ANNUAL SUBSCRIPTION:
£35 (UK), £50 (Continental Europe), £65 (rest of world).

ISSN 0969-4145

PRINTED BY:
John Good Ltd, Progress House,
Butlers Leap, Rugby CV21 3RQ
Tel: 02476 652800

The Processing and Packaging Machinery Association assumes no responsibility for the statements or opinions, whether attributed or otherwise, in Machinery Update.

This publication is copyright under the Berne convention and the International copyright convention. Apart from any fair dealing for the purposes of research or private study, as permitted under the Copyright, Designs and Patents Act 1988, no part of this publication may be reproduced, stored in a retrieval system or transmitted in any form or by any means in any form without prior written permission of the publishers.
Publishers: PPMA Ltd



Innovators in overwrapping and banding machinery

Improve your sales; overwrap your products

The benefits of overwrapping in short:

- Excellent appearance
- On-pack promotion with printed film
- Cost reduction
- Closed packaging
- No heat radiation
- Efficiency
- Ease of operation
- Flexibility
- Low maintenance
- Easy opening with tear tape
- Biodegradable film & paper



Over 10,000 machines sold world-wide!

01256 896930

PPMA

SHOW 2020

MEETING HUB

**NOW
ONLINE**

WHERE PRODUCTIVITY MATTERS

This year's meeting place
for processing equipment,
packaging machinery,
industrial robots and
vision systems.

**CONNECTING BUYERS
WITH SUPPLIERS
ONLINE**

ppmashow.co.uk



OWNED AND ORGANISED BY
PPMA GROUP OF
ASSOCIATIONS



PPMA Group of Associations is a trading brand of PPMA Limited.



PPMA matters

We shouldn't take anything for granted...



Tim Paul

CHAIRMAN, PPMA GROUP OF ASSOCIATIONS
(INCORPORATING PPMA, BARA AND UKIVA)

If there's one thing that COVID-19 has taught us over the past six months; it is not to rest on our laurels. For instance, who would have thought in the aftermath of leaving the European Union in January, some of the biggest names in retail, aviation and automotive would be seeking a potential government bail-out for very different 'non-Brexit-related' reasons?

Despite the economic turmoil, there is at least some room for optimism. There are certainly business opportunities to be had during these unprecedented times, even if the driving factors are often logistics and ensuring your business is COVID-19 secure.

Whether we like it or not, everything is going to take a little bit longer, at least until a vaccine is made widely available. Being able to adapt is therefore paramount, as we cannot ride out the storm of another nationwide lockdown. It's imperative that we find new ways of doing business, and in a sustainable way (our feature covering sustainability starts on page 64).

Today, using AI for remote diagnostics is no longer seen as a luxury, it is now a necessity

With several more food manufacturers being hit hard by COVID-19 outbreaks, there has been lots more discussion about robotics and automation. This, in turn, raises the question: Is greater automation the answer to maintaining social distancing? Turn to page 11-12 for a special BARA Webinar report.

I was asked recently if I thought this pandemic had forced more companies to think laterally? The simple answer is yes, although I think it is more sector driven as opposed to common practice for everyone. For industries such as life science, beverages, household goods – to name a few, they have certainly accelerated the process to bring about positive change.

Flexibility is also key for manufacturers overseeing multiple branded products, where one production line cannot make enough to keep up with demand, while another line is experiencing a downturn due to economic conditions. We have certainly seen some excellent examples of this, where companies have transitioned from manufacturing machinery to PPE for the NHS. Our special COVID-19 feature starts on page 34.

Businesses also now need to find a sustainable solution for engineers to service equipment in overseas locations in a world fraught with travel restrictions. Consideration should, therefore, be given to using artificial intelligence (AI) to assist with remote diagnostics; something that was previously seen as a 'nice to have', as opposed to a 'need to have,' today.

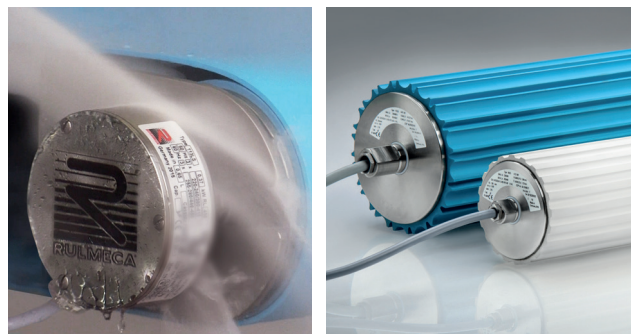
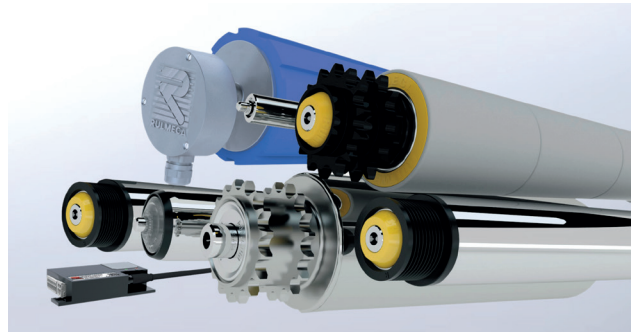

Rulmecca offers a **comprehensive range** of high quality rollers, drum motors and technologies covering the most demanding applications in material handling.

Components employed in **any industry**: airport security and logistics, postal and parcel handling, manufacturing and automation, packaging and palletizing, distribution, fish, food and beverage processing and warehousing.

We are close to you, whenever you need us, with a **global network** of sales and service centers.

BECAUSE PARTNERSHIP MATTERS.

Rulmecca UK LTD
Brunel Road,
Earlstrees Road,
Earlstrees Ind. Estate,
Corby, NN17 4JW
T. 01536 748525
rulmecca.com

Rulmecca.
Moving ahead.



BETTER PACKAGING & PROCESSING

Are you looking to improve the efficiency and sustainability of your packaging?

Is maximising profit and product yield at the top of your agenda?

Discover the full MULTIVAC product portfolio at our next packaging and processing industry event.

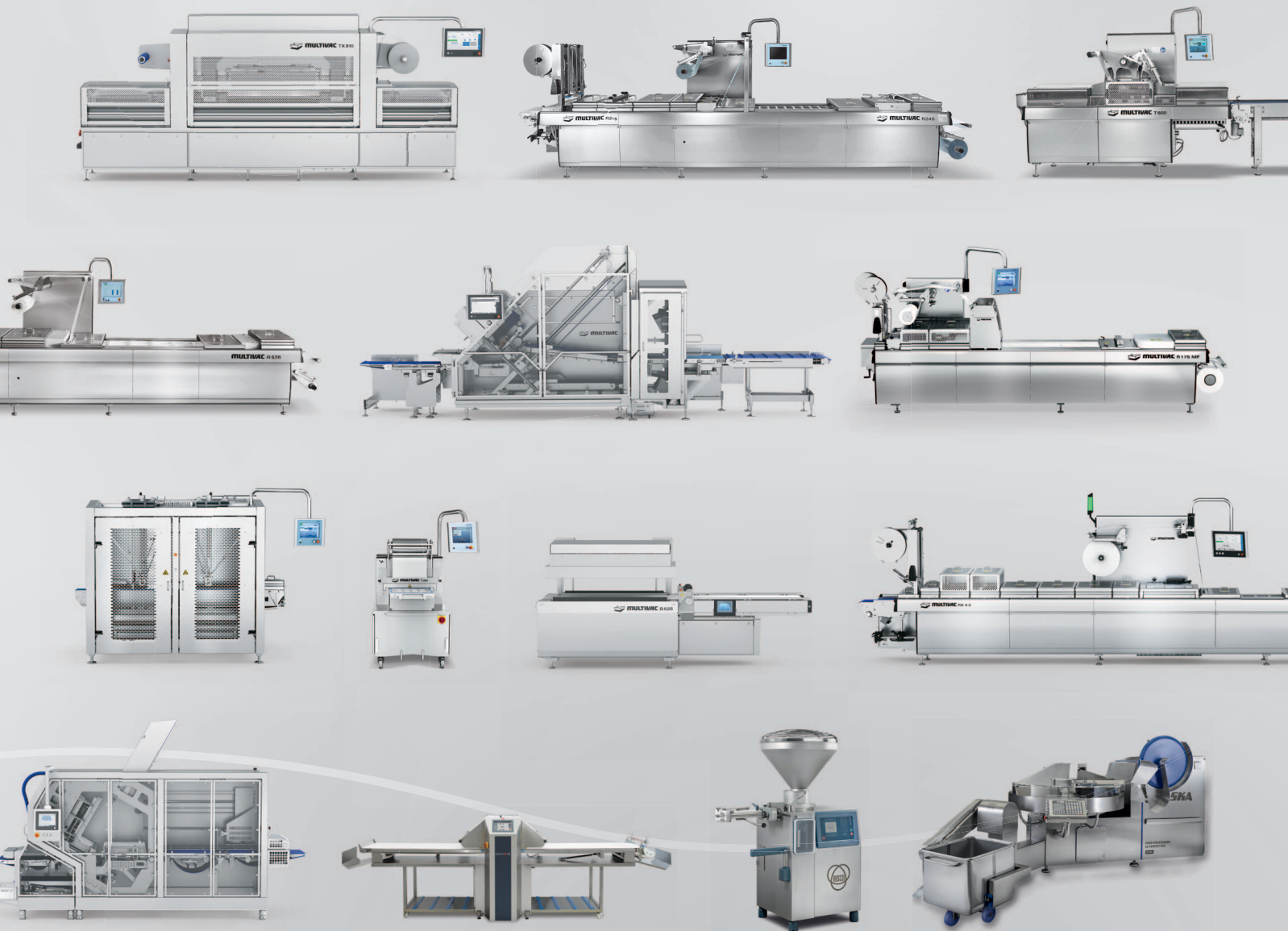

If you're interested in learning more about our events, contact us
events@multivac.co.uk · Tel. 01793 425800 · www.multivac.co.uk



OUR PARTNERS



News



Multivac is hosting this food event

Discovery Forum will share future view of food production

Multivac UK will host its Packaging and Processing Discovery Days on October 22-23, 2020 at its showroom facility in Swindon.

This annual open house will enable visitors to learn how their businesses can benefit from automation and efficient technology advances. Live application and machinery demonstrations and key industry speakers will also form part of the event, before the space will be transformed into a Bavarian Wunderland for Oktoberfest.

A Discovery Day+ will take place on the second day, for anyone looking for a one-to-one solution. Numbers are limited, so register on the website.

www.multivac.co.uk

Webinar event asked if C-19 would help automate food sites?

The British Automation & Robot Association (BARA) hosted its first virtual roundtable event

in July to discuss whether COVID-19 will drive greater adoption of robot automation in the food sector.

The webinar brought together industry professionals and academics from the Food and Drink Federation, Allied Bakeries, the University of Lincoln, the BARA Council, Schubert UK, James Mae Industries and the Lloyds Banking Group.

Chaired by this magazine's editor Gail Hunt, the seven panellists brought knowledge from the food manufacturing sector, automation suppliers and also from finance during the 90-minute discussion which also included questions from the audience. The panel



The virtual roundtable event was devised by BARA

agreed that social distancing guidelines could be the game-changer going forward. Especially while COVID-19 outbreaks within food factories continue apace; everyone felt this did nothing for the industry's reputation, but it was at least helping to highlight some of the issues.

Although cash-strapped food businesses have been slow to adopt new technology, the panel felt there was much "low hanging fruit" that could bring change without too much disruption and listeners were urged to consider the cost of ownership, as well as the cost of purchase.

• A full report on this event can be found on pages 10 and 11.



Meeting Hub will connect businesses

Following the unforeseen postponement of this year's PPMA Show, the PPMA Group of Associations has initiated a new Meeting Hub to connect buyers with machinery and services suppliers.

The hub went live on 7 September and is FREE-to-use. It provides a gateway to over 1,500 brands from over 300 PPMA Show 2020 exhibitors and is therefore the largest single gathering of processing equipment, packaging machinery, robotics, and industrial vision companies throughout the UK.

VERY LATEST NEWS

Visitors can join other industry professionals to experience an eclectic mix of exhibitor news releases, product videos and company information; all from the benefit of their home or office. It's the most comprehensive pool of industry information online until the live PPMA Show returns to the NEC, Birmingham, on 28-30 September next year.

"The Meeting Hub is an extension of our PPMA Show and each visitor to the PPMA Show website will have unlimited access to hundreds of exhibiting companies from across the processing and packaging spectrum," explains David Harrison, chief operating officer of the PPMA Group of Associations.

"It's not a replacement for our annual flagship event, but it is a valuable tool for those looking to invest in the latest innovations to improve business efficiencies," he added.

www.ppmashow.co.uk



NEW DESIGN DELIVERS CIRCULAR ECONOMY GAINS

Eco-packaging is rewarded

This 220ml water bottle, featuring a V-shape, has been devised by Sidel as part of an end-to-end packaging alternative for still water. It is an award-winning, sustainable concept that is designed to meet circular economy requirements while improving environmental impact and production efficiency. Find out more about this and other eco-developments in our sustainability feature that starts on page 64.

SPS 2020 cancelled and will now be an all-virtual event

Due to the ongoing travel restrictions and other fundamental changes caused by the coronavirus pandemic, Mesago Messe Frankfurt has decided to hold SPS 2020, the exhibition that covers smart and digital automation, in an all-virtual format.

"We're very disappointed to have to cancel this year's SPS event in Nuremberg," says Martin Roschkowski, president of Mesago Messe Frankfurt.

The main reason behind the cancellation was that many participants had their concerns for the well-being of their employees.

www.sps.mesago.com

Conference will give advice on microbiological issues for food

Gripping Matters



Finding the correct automated gripper solution is pivotal to maximising efficiencies & minimising costs

piSOFTGRIP®

Unique vacuum based soft gripper for handling sensitive & delicate objects



piCOBOT®

Small, powerful & ready to collaborate with human & cobot workers

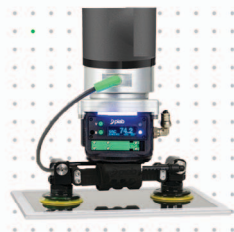

Large range of gripping systems

Configurable heads & large area grippers for all industries



Hybrid Bag Grippers

Robust palletizing and de-palletizing End of Arm Tools

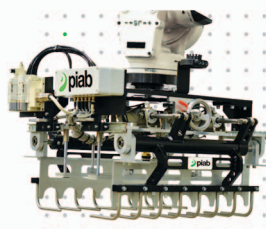

As COVID-19 continues to impact the food and drink sector, Campden BRI will hold a three-day online conference to help the industry understand how to control SARS-CoV-2 as well as other pathogens including Campylobacter and also Listeria.

This online conference, to be held from October 6-8, will cover the current and future microbiology issues affecting the safe production of food delivered by experts in the field. It is designed for food manufacturers, food and drink laboratory personnel, microbiologists and technical managers, quality assurance staff and food safety managers.

COVID-19 IS PLAYING A PIVOTAL ROLE IN FOOD

“The virus that causes COVID-19 has created the largest pandemic of our lifetime and it’s playing a pivotal role in many food and drink businesses’ decision making,” says Campden BRI’s Fiona Cawkell, manager of the Campden Microbiology Proficiency Scheme. “This makes our annual ‘hot topics’ in food microbiology conference possibly the most important to date, which is why we’ve brought together expert speakers to discuss how food business operators can guard against it.”

The usual suspects that cause foodborne illness, including Campylobacter and Listeria, also remain a public health concern and so experts from across Europe will discuss the issues they cause during the event and take questions from delegates to help them tackle the threats these pathogens pose.

www.campdenbri.co.uk

Smart solutions for the automated world™ 



CONNECTS

A new web-based event will replace Chicago exhibition

November's PACK EXPO International and Healthcare EXPO that were due to take place in Chicago have been cancelled and will be replaced with a new live, web-based event called PACK EXPO Connects 2020. The online event will take place between November 9-13 and include live chats, product and equipment demos and also educational opportunities.

PACK EXPO Connects will facilitate exhibitor and attendee interaction while continuing to provide the ability to see machinery in action through this new platform. It will also offer daily Jumpstart sessions on hot topics from industry thought leaders along with the Innovation Stages, a staple of previous shows, as well as the brand new Solution Room.

www.packexpoconnects.com



The centre is based at OWR's HQ

Robot demo centre brings user benefits

OW Robotics (OWR) has launched a robotics demonstration centre for businesses looking to transform their warehouse, logistics and manufacturing operations through automation. Customer processes can be replicated in a sandbox environment.

Training centre for Universal Robots has reopened for courses

As the UK lockdown eased, RARUK Automation reopened the UK's first Universal Robots Authorised Training Centre at its headquarters in Shefford, Bedfordshire in August.

RARUK Automation has issued a statement on Staying COVID-19 Secure in 2020 confirming that they have complied with the guidance on managing the risks. Social distancing will continue to be standard throughout the building and for training visitors they can expect to have no more than two people training at any one time.

There will be a temperature check on arrival for the trainees before they are escorted to their designated area.

The reopening allows the RARUK Automation certified UR trainers to continue to provide tuition in collaborative robot

programming. With its Authorised Training Centre Network, of which RARUK Automation is a part, UR training modules can be delivered in a local, classroom environment once more. They cover core to advanced cobot programming, including cobot scripting, preventative maintenance, overall system troubleshooting and also any parts replacement.

Check for upcoming courses here: <https://academy.universal-robots.com/raruk-automation/>



The UR training modules can be accessed again



supported by
Morrisons

Clever vision use is nominated for a Farming Award

Scorpion Vision has been made a finalist in the Machinery Innovator of the Year category in the British Farming Awards after the judges had a tough job narrowing down the entries to just four in each group.

VEGETABLE PROCESSING

The nomination is for the company's post-harvest vegetable processing systems for which it has worked with several robot partners to develop these automation systems for agriculture. Scorpion enables the robots with AI augmented 3D machine vision to inspect and create the optimum cutting positions on vegetables, at speed. It replaces people having to use large blades, often in damp conditions, to trim and cut various crops on the fly.

Winners will be announced at the Virtual Awards Night being held on October 21.

New rental scheme for over 200 machinery models helps cope with changing demands

Ishida Europe has launched a special rental scheme to help businesses effectively manage ever-changing circumstances resulting from the coronavirus pandemic.

The company is making available models from its weighing and quality control equipment portfolio, which can be rented for a minimum period of six months with full Ishida service support.

"Our rental option provides businesses with additional flexibility as they navigate

these unprecedented times and enable them to cope without having to commit immediately to new equipment." Over 200 models from Ishida's multihead weigher, checkweigher, x-ray inspection and AirScan ranges are now available to rent.

www.ishida.com

• More new services and products relating to the pandemic can be found in

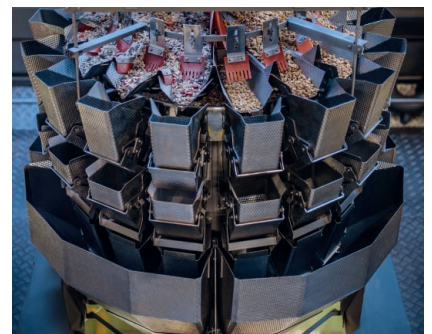

Over 200 models can now be rented from Ishida

our special COVID-19 feature that starts on page 34.

Will C-19 drive the adoption of robot automation for food?

The BARA (British Automation and Robot Association) Webinar in July gathered a panel of experts from the food industry, automation suppliers, education and banking to discuss whether C-19 and social distancing issues will advance robot use in the UK food industry

It's a well-known fact that the UK lags behind many of its trading partners in adopting robot automation in the food and drink sector but the COVID-19 pandemic has thrown a spotlight onto issues such as productivity levels and labour availability as well as social distancing within factories.

But what have been the barriers to their adoption? Chief executive of the Food and Drink Federation Ian Wright felt that the financial model is the first thing with access to capital a major difficulty, while the second is disruption in the factory and the third, was the lack of understanding by the people who sign the cheques.

CHILLED IS COMPLEX

Simon Pearson, director of the Institute of Agri-Food Technology at the University of Lincoln agreed, but also made a distinction between chilled food providers and long-life food producers. "It's much more complex to robotise chilled food operations, which are fresh-like operations, usually supplied into main retailers," he said. Meanwhile, chairman of BARA Mike Wilson agreed that there's lots of challenges in trying to apply robots and automation in handling the naked food product, but argued that there's still lots of opportunities to apply robots for end of line packing as, in reality, there are many food companies that still employ people to do some

very basic handling and palletising type applications.

Moving onto areas of current success, Martin Miller, the director of engineering and operations development at Allied Bakeries said that they did use robotics at all ends and in most of the industries that he'd worked within including snack foods through to abattoirs. "The packaging end is the easier end to do, but you are always doing it with one eye open as that's the end that could change very quickly," he said. For example, the upcoming plastics tax will cause issues, and the panic buying at the beginning of the COVID-19 outbreak saw certain SKUs spiked, and the

still plenty of opportunity for regular pick and place technology. "I guess everybody is squeezed at the moment, but the opportunities are still there," he told the Webinar.

Simon Pearson agreed on pick and place and went on to talk about COVID-19 and food manufacturing at the moment. He feels that anything that takes people out because of the virus is going to be really high on the priority list. "We know there's 69,000 fruit pickers in the UK, and so we're very active in that space, and also 121,000 people in food processing," he said. "We have got to think about how we're going to handle that

robots, that might be very attractive, even to businesses which are financially stretched," he said.

SOCIAL DISTANCING

Social distancing is also a potential gamechanger, particularly in applications such as sandwich making and convenience foods sectors. "If we keep getting these Covid-outbreak clusters coming from food factories, it's just not good for the industry and not good for the industry's reputation," said Simon Pearson. Mike Wilson said that for him, it's about trying to find, within any facility, the applications that are very suited to robots; the very mundane, the very repetitive, the arduous type of applications, but then keeping the people doing the tasks where you need their particular skills. "What that then potentially allows you to do is to spread the workforce out," he said.

But is it the availability of capital or financing that is holding back greater investment?

Availability of finance is the challenge for many and so David Atkinson, head of manufacturing SME & Mid Corporate at Lloyds Bank suggested that if a business was not experiencing the support that maybe you expected, think about who else you know that could provide the finance you need. "This could be another bank, different brokers; maybe the OEMs or the robotic

Crises are often the stimulants to real innovation and new ways of doing stuff

food service demand went to zero overnight.

Mark Stepney, managing director of Schubert UK said that today's shorter production runs demanded by most of today's food sectors meant that quicker changeover times were more and more important, while Bob Hinchcliffe, managing director of James Mae Industries said that flexibility had to be designed into an automation project right from the outset, to cope with all the SKU variants.

In terms of future success, Martin Miller felt there's

in the future, with a shortage of labour, and robotics is going to be key.

"There is an urgency that I have not seen before," he said.

Ian Wright felt that rather than think about the actual sector, it would be better to think about the nature of the workforce and the capacity to attract the workforce going forward as this was probably going to be a determinant of the businesses that are prepared to invest.

"If you could replace variants such as absence or difficult to reach places in the UK or migrant labour with

integrators themselves,” he said. They will all have their areas of specialism and credit appetite for different types of project or machinery.

He also advises to think about how to influence the decision makers in your own business before you go to them for the decision. “Think about how you de-risk those projects and get some expert help in order to help secure that finance,” he explained.

Mark Stepney said that those wishing to automate should definitely approach their OEMs and Schubert, for example, have a financing partner, to make things easier for customers, especially as these companies understand residual equipment values. “If you go the lease direction; operating lease direction, essentially, you don’t start paying for the equipment until it’s in your factory and earning you money,” said Stepney.

VISION TECHNOLOGIES

In terms of technologies that will make adopting robotics easier, Bob Hinchcliffe felt one really big game changer is the development of vision technology. “Combine neural networking with the new 3D vision cameras, and we will see massive changes across the machine vision spectrum,” he said. While what has



Ian Wright



Simon Pearson



David Atkinson



Mike Wilson



Mark Stepney



Bob Hinchcliffe

struck Simon Pearson in the past three months is the power of digital twins, as he’s been developing some very advanced picking robotic systems through lockdown. Twenty people working on it collaboratively all over

the world via a digital twin. “They de-risk, give more flexibility and you can do more ‘what if’ statements,” he said.

And finally, many of the panel felt that there would be an increase in robotic

automation adoption in the coming years, for all sorts of reasons discussed in this article. And as Ian Wright said: “Crises are often the stimulants to real innovation and new ways of doing stuff.”

www.bara.org.uk

Devising a half-way house could be key to food manufacturers adopting robots

Robot integrators need to listen to their customers more closely before coming up with an all-singing, all-dancing option, says a senior food industry engineer.

When asked what system integrators could do differently to make robotics more appealing for food manufacturers during a BARA Webinar in July, Martin Miller, director of engineering and operations development at Allied Bakeries said the following: “Help us find a halfway house, rather than going straight to lights out.

“I get so many offers of here’s your solution that will take everybody away and that’s when you hit the problems,” he told the panel. “I can think of lots of examples

where I’ve put automation in and then taken three bodies out per shift, only to find you’ve missed some of the nuances of what some of these guys do,” he continued.

“Everyone wants to sell their lights out solution, but nobody wants to actually really work with you to implement the technology in perhaps three steps,” he said. Why not admit that it’s going to be a journey, he asked.

“If I was going to ask for one thing, it is how can you break it down into component parts so that you don’t miss anything,” he said. “When you are finally brave enough to take the last person out, you have to know that you’ve got every base covered.”



Martin Miller

New Machinery



The new TP5000 teach pendant

Controller makes robot cycle faster

TM Robotics has released the new TS5000 robot controller which forms a launch pad for the next generation of industrial robots from Shibaura Machine — formerly known as Toshiba Machine. Boasting faster position control, the TS5000 improves robot precision and shortens cycle times in operation.

Compared to previous controllers, the TS5000 has been designed to improve synchronisation and control. Its position cycle is three times faster than previous models, allowing more control during fast movements, and combined with an automatic adjustment function for acceleration, these features reduce vibration and stress.

Communication functions of the TS5000 have also been enhanced. The controller enables real-time data transmission between the robot and controller, allowing manufacturers to integrate the system into a smart factory environment. This improved communication also enables vibration analysis for predictive and preventative maintenance.

The new TS5000 also has dedicated ports for status feedback and control, allowing additional ports for priority communications such as vision interfacing and control. For non-protocol communication, the TS5000 boasts eight ports — a four-fold increase on the previous model.

Alongside the new controller, TM Robotics has released the new TP5000 teach pendant as an optional add-on.

T 01707 290370

W www.tmrobotics.co.uk

New partnership allows wider filling range offer

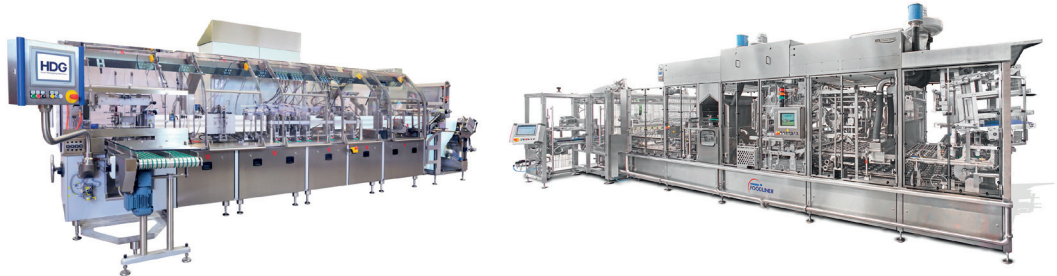

Grunwald UK, HDG and Wolf believe their combined strengths and capabilities will prove successful for food clients

Grunwald UK has extended its filling machine range through a strategic partnership with HDG and Wolf — part of The Packaging Group GmbH. This partnership will see Grunwald UK work alongside the existing UK Packaging Group sales team to augment the sales coverage for the HDG and Wolf brands with a particular focus on the liquid food market segments.

In addition to the existing cup and bucket filling machines already available through Grunwald UK, the range of high performance horizontal and vertical form, fill and seal machinery for side sealed pouches, sachets,

classic pillow bags, doypacks and gusseted bags, and many other options can also now be supplied.

INCREASED DEMANDS

The partnership will enable Grunwald UK to meet an increased demand from customers to handle filling projects from a small sachet right through to a 15 kg bucket, with an extensive range of solutions being offered.

“It is important for us to be able to offer the broadest possible range of filling machinery to give the best support to our customers, old and new,” explains James Causebrook, managing director of Grunwald UK.

Samantha Smith, Grunwald UK sales and projects director believes it is clear that the range of equipment offered by HDG and Wolf perfectly complements the high standard of engineering demonstrated by the existing Grunwald range.

“As we look to further develop our machine brands, it is great to be in partnership with a company that has extensive knowledge of the packaging technology landscape within the UK, Ireland and the US food industry,” says Tony Marlow, area sales manager for The Packaging Group GmbH.

T 01529 414999

W www.grunwald-uk.com

Localised dust extraction system enables a sack tip sieve to be cleaner in operation

Farleygreene has launched a localised dust extraction system (LDEE) to operate with its Sievmaster Easilift sack tip sieve. The new LDEE is based on the company’s Sievmaster Easilift sack tip station and it can be fully integrated into production lines to enhance and improve all aspects of safety and hygiene while sack tipping powders.

“The concept originally came about following a customer request,” explains Daniel Morlan, area sales

manager at Farleygreene, “but the design has proven to be a successful addition to our popular Easilift model and so is now available for general sale”. The LDEE model incorporates a horizontal filter and side mounted

fan system, which is built onto the back of the sack tip hood.



The LDEE model from Farleygreene offers hygiene

T 01256 474547

W www.farleygreene.com

Think you know Yamato? Think again...

Yamato are market leaders in multihead weighing **AND** product inspection.

NEW! Yamato YX20 Xray

- Contaminant detection
- Scan for missing/broken products
- Integrated checkweigher (option)
- IP69
- Fully integrated loadcell (option)

Yamato I Series checkweigher

- Infeed weigh and reject conveyor
- IP67
- Reject bin guarding and fail safe



Welcome **The New Modular Pallet Conveyor Platform – MPP**

Interroll now offers a fully integrated, robust, space- and energy-saving solution for the high-throughput handling of pallets. We call it MPP.

- Roller or chain pallet conveyor modules
- Specialty conveyors such as lifts, check stations and more
- Fully modular platform allows for easy design and configuration
- Stacker Crane and Transfer Car for smooth integration with Interroll Pallet Flow

New Machinery

Easy-to-use machine is launched for on-demand cushioning range



Antalis has extended its range of protective packaging solutions with the introduction of the new PadPak Guardian from Ranpak which brings together many of the benefits of other Ranpak converters into one compact, fast and simple-to-use machine.

PadPak Guardian is an in-the-box solution that is able to convert both single and two-ply paper, offering businesses greater versatility from just one machine and providing a sustainable alternative to traditional plastic cushioning. In operation, paper is fed from a pre-folded block into the converter to create a variety of cushioning pads, on demand.

ADAPTABLE OPTIONS

The converter is extremely adaptable – with options to work at height or lower – and can be moved around the packing area with ease. Its neat design and size means it can be positioned in tight corners to maximise use of space while also improving process flow.

With three speed settings – producing up to 1.2 m of pads per second – and five operation modes managed by touch screen, the PadPak Guardian can help to optimise production whatever the demand. From automotive to e-Commerce, Antalis says it is suited to almost any packaging environment thanks to its ability to produce pads that offer strength or flexibility, depending upon what's required.

The new pads can be used to cushion both light and also heavy items.

T 01530 505099

W www.antalispackaging.com

cap@coder

UK MANUFACTURED PACKAGING MACHINERY EXCELLENCE

- Turnkey solutions • Filling • Capping • Labelling
- Automation • Bespoke, special purpose design
- Pharmaceutical • Food and Beverage • Chemical
- Aromatherapy • Medical • Diagnostics • Ecig • Adhesives

To discover more about the machines that could transform your company please visit:

www.capcoder.com

Tel: 01865 891466 Email: sales@capcoder.com



Still waters produced more efficiently with less space

Two years after the initial launch, Sidel is introducing the next-generation of Super Combi Compact that, as indicated in its name, is even more compact. Allowing up to a 30% reduction in footprint compared to the previous model, the solution also offers efficiency enhancements for still water production thanks to the new filling technology embedded in the Sidel EvoFILL HS Still. This new development is said to guarantee a 30% faster performance.

With the Super Combi Compact, Sidel presents a product that is designed and engineered to deliver the lowest total costs of ownership (TCO) and production costs per sq ft to meet customer demand for optimising all company resources.

Like its predecessor, the Super Combi Compact is integrating five process steps – preform feeder, blower, labeller, filler/capper and cap feeder – into an all-in-one,

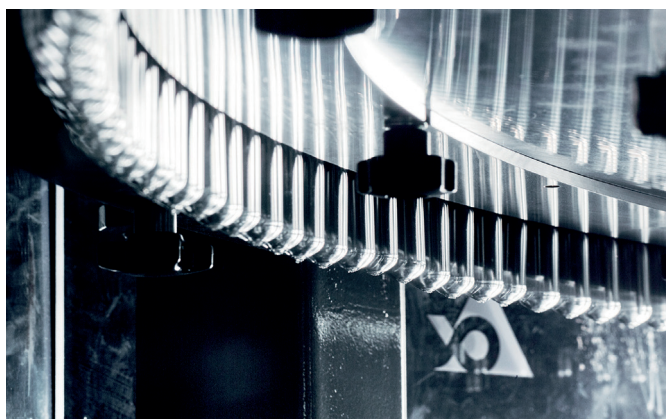

The Super Combi Compact option saves factory space for still water makers

smart system to deliver 54,000 bottles per hour (bph) in a reduced space. Furthermore, its ergonomics and the latest technologies support easy access, operation and maintenance while ensuring high end-product quality, says Stefano Baini, product manager filling and Super Combi at Sidel.

Maximum productivity is delivered by the range of improvements at the blowing, filling and labelling stages.

The new filler with

proportional filling valves, controlled by electro-magnetic actuators, guarantees a 30% faster filling with total control and accuracy when it comes to dosing the liquid into its designated container.

“EvoFILL HS Still is a simplified solution characterised by fewer components and functions, resulting in less maintenance costs, and a highly reduced filler footprint with less filling valves,” explains Baini.

T 01707 292820

W www.sidel.com



New cobot offers solution for a post lockdown factory

Fanuc's new lightweight collaborative robot (cobot) is now available to UK customers.

Called the CRX-10iA, this 39kg cobot was launched at IREX last year (see page 23, March/April issue), and is a compact cobot aimed at manufacturers looking to increase productivity while adhering to current social distancing guidelines.

“As with all cobots safety is key, but we've also made installation and set up as straightforward as possible,” says Andy Armstrong, sales and marketing manager at Fanuc UK. “An intuitive touchscreen panel allows programming to be completed through a ‘drag and drop’ function, which means those new to automation can create work programs quickly and easily,” he says.

T 02476 053000

W www.fanuc.eu

ADPAK **30**
YEARS
IN BUSINESS
PACKAGING SYSTEMS & FILMS
www.adpak.co.uk



Providing Your Complete E-Commerce Packaging Solution



- Innovative e-commerce packaging for professional mail order businesses
- Efficient and cost saving packaging
- For despatch or returned products
- Increasing capacity
- Rapid pay-back on capital investment
- Suitable for use with recycled packaging materials

New Machinery

Crate destacker offers maximum flexibility

Brillopak has launched a new dual crate DESTAKER for feeding empty retail crates to food packing lines at high speed and with maximum flexibility. Based on the same proven operating principle as the original system, the new version destacks two stacks simultaneously, to allow 18 crates per minute to be handled and the servicing of multiple packing lines.

Brillopak's Crate DESTAKers are employed in packing facilities for food products ranging from fresh fruit and veg to meat, baked goods and pizzas. Rather than picking up the entire stack and relying on gravity to despatch the bottom crate in operation, the Crate DESTAKER clamps the bottom crate down, lifts the rest of the stack up, and then despatches the bottom crate.

In a typical packing hall set-up, crates are transported to the line via forklift by the pallet load (usually about 30 to 40 crates high). The pallet load is pushed onto



In operation, the new Dual Crate unit handles 16 to 18 crates per minute

an accumulation conveyor that feeds stacks (usually five crates) into the crate destacker, leaving operators free to focus on other tasks while the machine continues to destack onto the line.

In its original single stack configuration, the machine operates at speeds of between 8 and 9 crates per minute. By lifting two stacks simultaneously, the new

Dual Crate unit handles 16-18 crates per minute, giving food producers and packers a high output option.

The units can be supplied as a stand-alone system, to integrate with a factory's existing packing automation system, or in conjunction with the UniPAKER robot, also from Brillopak.

T 01622 872907

W www.brillopak.co.uk



New liquid filler is an efficient and a sustainable option

Rovema has further developed its vertical continuous form, fill and seal machine to develop a new version to handle liquids destined for food service customers. The BVC 310 Liquid is now available with a fitment option for use in portion dispensers as hygienic product removal is essential for many system restaurateurs.

Even lumpy products in brine can be packed in low-air pillow bags, says the company. This application can replace rigid packaging such as buckets or cans as a more sustainable option. This flexible solution, for instance, uses less packaging material in terms of volume and weight without compromising on product shelf life and quality.

T 01296 310490

W www.rovema.com

Packline *Materials Handling*

www.packline.co.uk

- Bespoke Design
- Compact and Manoeuvrable
- Interchangeable Attachments
- Stainless Steel Construction
- Lifting Capacity up to 300kg
- Handle Reels of Film or Foil, Drums and Barrels



Conveyor accessories upgrade is delivering greater user flexibility

Travtec has upgraded its conveyor accessories range to offer increased flexibility and versatility for users of its coding solutions.

The Diverter, Paratran, and Mini-press all now feature a new drive assembly for improved speed and accuracy. An all stainless-steel construction with full IP66 certification allows easier installation and maintenance and enables the equipment to operate in the harshest of factory environments.

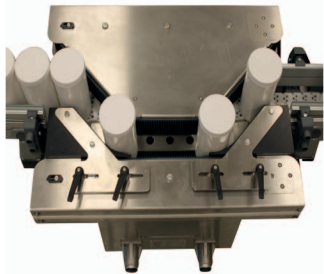

The Diverter now offered by Travtec

Offering two separate solutions for the coding of information onto the base of packs and containers, including bottles, jars and cans, are the Diverter and Paratran. The Diverter is designed to be mounted onto existing conveyors up to 150 mm wide to provide a compact solution where space is at a premium, while the Paratran is installed between existing conveying lines.

Both models can be integrated with either continuous ink jet or laser coding equipment, and both can also be used for inspection operations, using a vision system or barcode scanner. Adjustment between container sizes takes only seconds, and the synchronised, twin side-belt drives ensure positive control and guidance.

T 01942 677664

W www.travtec.co.uk



envision:ensure **Anritsu**

Discover What You've Been Missing ... DETECTION PERFECTION

Then contact Anritsu – The Industry's most Accurate and Reliable Product Inspection and Contaminant Detection Equipment.

Anritsu's commitment is to be YOUR Best Partner for Advance Food Safety and Guaranteeing Product Quality.

Please Call US to Test YOUR Product and receive a FREE Comprehensive Product Test Report.



ANRITSU INFIVIS LTD.

<https://www.anritsu.com/infivis>
Unit 3, Scott Road, Luton, LU3 3BF, UK
TEL: +44 (0)845 539 9729



New Machinery

New robot is a compact option

The new, ultra-compact KR 4 Agilus small robot from KUKA is designed to offer high performance at a favourable price. It is designed optimally for the standard workspace of 600 x 600 mm which is customary in electronics manufacturing and for a

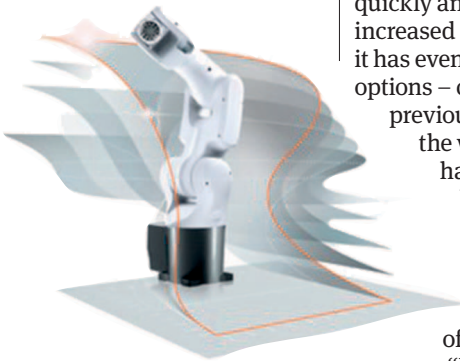

The KR 4 Agilus from KUKA offers gains

in a multitude of handling tasks in other industries that have limited production space in factories.

The potential for automated production processes is virtually unlimited with the

new model in the payload category up to 4 kg – not only in the electronics industry, but also in many other sectors. The robot can be installed in any position either on the floor, wall or ceiling, and at any angle.

In operation, the robot moves loads of up to 4 kg quickly and safely. With its increased reach of 600 mm, it has even more application options – compared to previous generations, the work envelope has been expanded by almost 40%.

At the same time, KUKA says it delivers precision in a minimum of production space.

“With the KR 4 Agilus, we are not just closing a gap in KUKA’s

portfolio, we are supplying a new small robot in the 4 kg class that is a real ‘big hitter,’” says Markus Hollfelder-Asam, portfolio manager at KUKA.

T 0121 505 9970
W www.kuka.com

Smart system will bring control gain

Dustcontrol UK has entered a new era of smart technology with the launch of two comprehensive control systems that are set to cover up to 90% of its stationary units worldwide.

“Our new Smart Panel and Base Panel will be a gamechanger in the way our stationary machines are

operated, offering a high degree of functionality and automation as standard,” explains James Miller, md of Dustcontrol UK.

The Base Panel is a standardised and configurable product with a clear and simple definition of functions and built-in frequency drive. It has been developed as a compact and efficient control system suitable for the central vacuum systems. Meanwhile, the Smart Panel comes in a compact,

standardised format and delivers a configurable solution suitable for the majority of Dustcontrol’s

more complex installations. It will be used in combination with an energy-efficient, externally mounted frequency converter for starting and controlling the motor to

deliver Industry 4.0 benefits.

“Ultimately, the new technology will give us significant benefits in terms of preventative maintenance, as well as helping us provide better service and support to our customers,” says Miller. Smart Panel is delivered ready to be connected to Dustcontrol UK’s cloud-based solution, enabling data logging, monitoring, and control of the system.

T 01327 858001
W www.dustcontroluk.co.uk



More control is now offered



Manufacturers of Bespoke Depositors for the Ready Meals Industry



Riggs Autopack Ltd • Premier Mill • Brunswick Street • Nelson • Lancashire • BB9 0HU • UK

T: +44 (0) 1282 440040 • E: info@riggsautopack.co.uk • www.riggsautopack.co.uk @riggsautopack

Tray system provides optimum positioning

Proseal has launched a tray positioning system – billed as the first of its kind - that calculates the required tray-spacing set-up parameters for individual tray sealing tool-sets, eliminating the trial and error usually associated with this process.

The new patent-pending ProPosition feature automatically identifies the best position for trays, to ensure the perfect alignment every time. Its advanced technology provides food manufacturers and processors with a simple one-step tool-set-up while removing the time consuming and potentially wasteful process of running test trays through the tray sealer to ascertain the best position.

Instead, operators are guided through the set-up via easy to follow animated instructions on the machine's touch screen. The system then permanently saves the relevant parameters for each tool, which greatly speeds up product changeovers and avoids operator errors during set-up.

ProPosition is fitted as standard to all new Proseal GT platform machines. Additionally, as part of Proseal's ongoing strategy of futureproofing its equipment,



The latest feature eliminates the usual trial and error process

the software can be retrofitted to any pre-existing machines which have the suffix GTe and GTs.

“The new system showcases our incredible engineering innovation and underlines Proseal's commitment to being at the forefront of product development and innovation,” claims Paul Watkin, Proseal systems development manager. “This pioneering technology helps to minimise downtime, reduce errors and minimise waste to deliver valuable cost savings that will deliver a fast return on investment,” he says.

T 01625 856600

W www.proseal.com

New inline barcode verifier operates at a high speed to provide user assurance

Cognex has launched the new DataMan 475V inline barcode verifier to provide contract-compliant assurance in

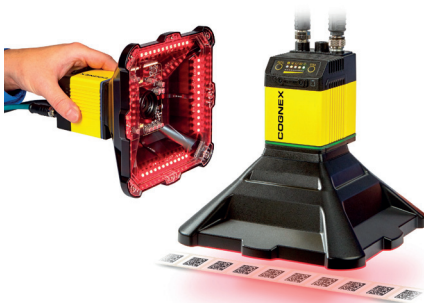

A DataMan 475V does not slow down production

adherence with the International Organisation for Standardisation (ISO).

This high-speed system delivers the most reliable code verification and quality reporting for 1D, 2D, and direct part mark (DPM) codes, says Cognex.

DataMan 475V ensures quality compliance for every code without slowing down production and is equipped with precision optics, powerful lighting, robust grading algorithms, and a high-resolution camera to capture and grade even the most difficult codes.

T 0121 296 5163

W www.cognex.com

MARTEK Boltmark-II Inkjet Printers



Next generation industrial inkjet printers



Anti Clogging Power System

Optional ACPS prevents ink clogging after power interruption

Optional IP65 protection

Opaque, pigmented inks

Print with pale inks onto dark products



martekindustries.co.uk

01543 502202

sales@martekindustries.co.uk

ALRAD

50 YEARS 1970 - 2020

Machine Vision



The Imaging Source have a full range of colour and monochrome industrial cameras for Machine Vision applications



UV-C Sterilization and disinfection systems help reduce the risk of infection



Bitflow Frame Grabbers

CoaXPress or Camera Link frame grabbers for Machine Vision applications



Line lasers for factory floor safety zone demarcation

Tel 01635 30345
www.alrad.com

New Machinery

Italian pallet stretch wrappers in the UK

Yorkshire Packaging Systems (YPS) is now in partnership with TOSA, an Italian manufacturer of stretch wrapping machinery.

This new tie-up means that an exclusive range of premium, high-speed fully automatic pallet wrapping systems

can now be brought to the UK market. TOSA's newly launched range includes three distinct models of pallet wrapping machine - turntable, rotating arm and rotating ring - all of which are fully automatic.

Variations of these models are available to suit differing applications, such as extra-wide for very large pallets, stainless steel for food and drinks products, machines incorporating top sheet dispensers for dusty, damp environments or vertical corner application units for corner protection of items. Each model can be supplied with a choice of film carriage, loading ramp, conveyor

configuration and wrapping cycle for a truly tailored solution, says YPS. As standard, however, every machine in the range boasts an intuitive user interface, a pre-stretch unit to get the maximum yield from every roll of stretch film and a film roping feature for

maximum load stability. "Every aspect of the design and build conforms to TOSA's

philosophy of high performance, low maintenance," says YPS managing director Glyn Johnson.

YPS supply and fit every TOSA machine with a comprehensive service contract free of charge and an extensive warranty.

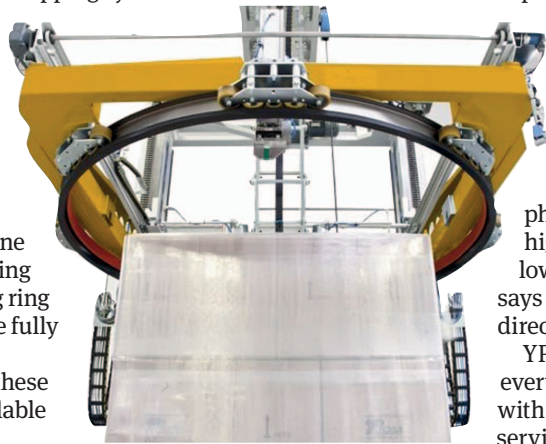

Pallet wrapping stretch films are also available

The company can also combine the TOSA stretch wrapping machinery with the supply of stretch films in a range of sizes, thicknesses and stretch ratios, all of which can be delivered next day across the UK.

T 01924 441355
W www.yps.co.uk

X-weigh feature identifies any weight discrepancies in all packaged products

Food manufacturers can provide retailers with assurances that their packaged products contain at least the quantity displayed on the label, and not less, thanks to a development from Loma Systems. Intended to be used to

complement end-of-line check weighing, the X-weigh feature is now available on the companies X5 x-ray system. It is fast to set-up and uses algorithms to convert data from an image into a weight.

Weight discrepancies in packaged goods can occur when products contain multiple sections - such as yogurts or ready meals. Whereas a checkweigher will only check the total weight, X-weigh will check all compartments separately to provide both an overall and an individual weight for each and any discrepancies are now flagged by X-weigh.

T 01252 893300
W www.loma.com



Checking for any weight fluctuations is easier



Printing and labelling across your production line

Product identification ◆ Brand protection ◆ Industry 4.0

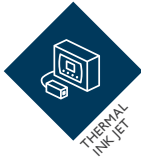

Domino understands that integrating innovative, new equipment into the toughest production lines requires reliable, compliant products, simple integration and a consistent global support infrastructure. We have already launched products, including our **new Thermal Inkjet Gx-Series printers**, which offer in-built future-proofing to keep pace with customers' increasingly intelligent factories.

Domino are trusted by a wide range of **food, beverage, life sciences** and **industrial manufacturers**, as well as global packaging machinery manufacturers who partner with us to offer fully-integrated solutions with customisable options.



Learn more:
www.domino-printing.com

Domino. Do more.

New Machinery

Mobile robot range gets a heavy payload option

Omron has introduced the HD-1500 mobile robot which is described as the strongest and newest addition to the company's range as it boasts a heavy payload capacity of up to 1500 kg. It has been designed for factories where autonomous materials handling solutions need to manage more demanding industrial automation tasks, along with implementing new social distancing requirements due to the COVID-19 pandemic.

The 1500 kg payload capacity of the HD-1500 enables transportation of large automotive components such as car chassis and voluminous pallet size payloads – items that would have traditionally been moved using forklifts. The launch means Omron's mobile robot range can transport a wide variety of items – from components to work in progress, finished products and heavy materials.

Ensuring efficient materials handling in factories, Omron's



The HD-1500 offers 360deg safety coverage to provide a safe working space

Fleet Manager can control up to 100 mobile robots of differing sizes, configurations and payload capacities under one system to automate complex material transport and logistics applications. The robots can automatically calculate the best route while collaborating safely with people and navigating around obstacles, without the use of magnetic floor tapes or other guides.

The HD-1500 battery charges in just 36 minutes and can handle a full shift on a full load, to help reduce

any possible downtime.

“Onsite logistics, the movement of products and materials within the factory and warehouse, is becoming a real bottleneck for many companies due to the frequency and tediousness of the job, compounded by the need to meet social distancing protocols,” explains Tom Mathias, president, and ceo of Omron Robotics and Safety Technologies. “Fast-paced manufacturing environments require speed and flexibility.”

T 01908 258258

W www.industrial.omron.co.uk



Multiformat palletisation offer

Multiple palletising solutions are offered to meet user needs

ixapack Global says its compact and modular palletising solutions are suitable for handling a layer, a row or a unit picking operation for cases, bundled packs, bags or buckets. These palletising solutions are designed to be flexible and enable various stack positions to be handled in a variety of layouts.

An automated robotic islet enables the company's robot palletiser to handle up to 4 lines simultaneously, thanks to fast and controlled cycle times, in a secure enclosure, while its Cartesian option is ideal for single-line palletising. This economical solution has a reduced footprint and also automatically places interlayer sheets, as does the robotic islet option.

T 00 33 5498 20580

W www.ixapack.com

Having difficulties pumping your product?

Just some of the products we pump...

- ✓ Honey
- ✓ Petroleum Jelly
- ✓ Mascara
- ✓ Sauces
- ✓ Lanolin
- ✓ Lip Gloss
- ✓ Essences
- ✓ Eye Ointment
- ✓ Meat Paste
- ✓ Paraffin Wax
- ✓ Face Scrub
- ✓ Teething Gel
- ✓ Tomato Puree
- ✓ Medical Adhesives
- ✓ Veterinary Creams
- ✓ Fruit Paste
- ✓ Toothpaste
- ✓ Malt
- ✓ Jam
- ✓ Wax



Traysealer range is redeveloped to boost speed and performance

Ulma Packaging UK says it has developed one of the fastest traysealers on the market to meet food processor demand for quick and energy-efficient packaging of meat and also all types of vegetable produce.

The TSA traysealer range has been tested to prove a capability of 20 cycles/min for modified atmosphere packaging, while in cut and seal applications, these speeds increase to 25 cycles/min.



Higher speeds are offered on both

This new traysealer can also integrate into existing packaging machinery lines, including single and double-lines, with box or tray distribution and palletising. Further advantages of the range include a powerful 10 tonnes of sealer force, for guaranteed safe hermetic sealing, which achieves low residual oxygen levels of between 0.1 and 0.2%. And to reduce energy outputs, a single vacuum pump is used.

“All TSA models are equipped with our UPC 4.0 control system, allowing for further efficiency measurement and optimisation, and the possibility of remote servicing, which is a key priority while social distancing continues to affect in-person technical training and assistance,” says Dave Berriman, technical sales support manager at Ulma Packaging UK.

T 01909 506504

W www.ulmapackaging.co.uk

Atwell self-adhesive Labellers

Fast, Reliable and Easy to use Semi Automatic and Bespoke Fully Automatic Labelling Systems

Whatever you produce,
Our machines will label it

Designed For Your Application

- Labelling Systems
- Labels & Consumables
- Contract Labelling



■ BESPOKE DESIGN AND BUILD ■ FULLY AUTOMATIC LABELLING SYSTEMS ■ SEMI AUTOMATIC APPLICATORS
■ PRINT AND APPLY UNITS ■ DESK TOP PRINTERS AND INLINE CODERS ■ LABELS AND CONSUMABLES
■ CONTRACT LABELLING ■ SERVICING AND CONTRACTS ■ RENTALS



www.labeller.co.uk

T: +44 (0) 1444 239970

E: sales@atwell-labellers.co.uk

18 Bolney Grange Business Park • Hickstead •
West Sussex • RH17 5PB • UK



New Machinery



Automation designed as a safe option

Festo has further developed the BionicMobileAssistant, a prototype robot system that deploys artificial intelligence to move independently, identifying and gripping objects and adaptively working with humans. The company believes the system is perfect for differentiating good product from bad product, or for use as a personal assistant: for example, as a service robot helping in assembly or assisting workers in carrying out ergonomically monotonous work tasks.

It has a modular design consisting of three subsystems: a mobile robot, an electric robotic arm and a pneumatic gripper – the BionicSoftHand 2.0 – an earlier version of which was first presented by Festo last year. It uses a combination of compact valve technology, sensors, electronics and mechanical components integrated in the tightest of spaces in order to emulate the movements of a human hand.

BionicSoftHand 2.0 wears a tactile glove with force sensors on the fingertips, the palm and the outer sides of the robot hand. This allows it to sense the nature of the item to be gripped, and to adapt its gripping force accordingly – just as the human hand does. Thanks to a 3D-printed wrist with two degrees of freedom, the hand can also move both back and forth as well as to the left and to the right.

T 01252 775053

W www.festo.co.uk

Smart pallet mover will automate the 'last mile'

With the Smart Pallet Mover (SPM), Interroll will be offering a new, mobile robotics solution for the automation of pallet transport around production machines and order picking.

This flexible and scalable solution represents a mobile and autonomously operating transport system that can be used, for example, as a cost-effective enhancement of static conveyors. It replaces manual processes which have so far been carried out by hand or by forklifts and is designed to transport pallets or boxes weighing up to 1000 kg.

The new development follows an Interroll survey carried out last year covering production logistics in SMEs which found that not quite one in five manufacturing companies achieves more than a 75% degree of automation in their material flows. However, these companies are aware that automation would improve accuracy and safety in their

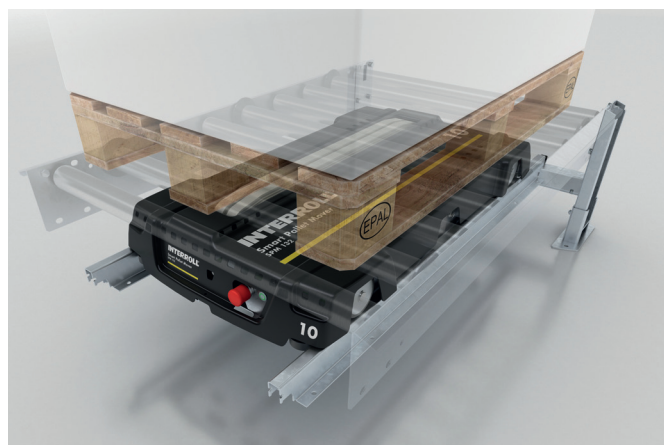

Interroll is developing this robust, simple and yet digitally-ready solution

operations and are therefore looking for robust, simple and yet digitally-ready solutions to deliver this aim.

The modular SPM consists of several components. It has a battery-operated drive that runs on rails and autonomously moves modular conveyor units with pallets or boxes. Depending on the solution, special modules such as pallet magazines are also available. It also has height-adjustable feet to give

additional flexibility and also enable the system to be installed on uneven floors, if required.

Designed to be easy to install, to operate and to maintain, this plug and play solution can be put into operation without lengthy production downtime, while an online tool makes it possible to configure the system quickly and easily.

T 01536 312770

W www.interroll.co.uk

A compact traysealing solution will support the rapid response needed in 'new-normal'

G Mondini UK has launched the Trave 384R, a simplified and more compact version of the original traysealing option, but still offering the same high line speeds, build quality, seal integrity, hygiene, and food safety.

Built with flexibility in mind, the new compact design further supports businesses with quick changeover tooling which increases machine availability and productivity while continuing to support a wide range of food

packaging applications. These range from meat, fish and poultry to ready meals, dairy and pet food.

The Trave 384R is built for heat seal, gas flush, vacuum skin and vacuum skin protruding applications and,

as standard, the package includes the tray sealer, a complete sealing tool, a tool trolley, delivery, installation and commissioning as well as an extended warranty.

Built to stock in the UK, the Trave 384R is available with rapid delivery options and flexible commercial agreements to support customers with ever-evolving demands.

T 01785 812512

W www.gmondini.com

The new unit will be built to stock in the UK

CEIA

INDUSTRIAL METAL DETECTION



NEW



THS/MBHD

**MARKET'S MAXIMUM PERFORMANCE
ON HEAVY PRODUCT SIZES**

NEW



THS/FBBV AND THS/FBV

**SPECIFIC DESIGN FOR VERTICAL-ORIENTED
PRODUCTS**



CEIA AUTHORISED DEALER

► Contact us on: 0161 286 8750 [TECHNICAL] - 0161 286 8755 [SALES]

www.mds.org.uk

UK FULL SERVICE AND TECHNICAL SUPPORT

- 24-7 Help Line and Assistance
- Metal Detector Validation and Retailer Code of practice training

Installation News

Cartoning machine embraces a smart design for total flexibility

In a recent project, Cama was tasked with designing and integrating one of its CL 175 cartoning machines into an electrical component fabrication line at one of the world's largest automation vendors Rockwell Automation.

In addition to proving the integration capabilities of the control solution, Cama had to demonstrate that its machine would fit seamlessly into the rest of the line, the majority of which had been developed and built by US company Calvary Robotics, a specialist in the design and build of automated assembly, test and material-handling systems.

The line is designed to be as flexible as possible, so that small batches of the various contactor models can be fabricated – to order just-in-time – as efficiently as possible, with minimum re-engineering and downtime. “As a result, our packaging solution had to deliver a commensurate level of flexibility, to adapt and change to the various product

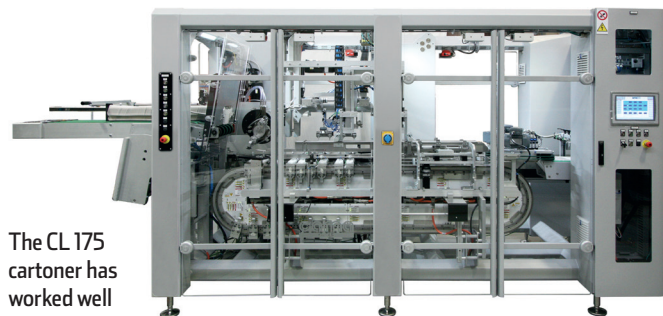

The CL 175 cartoner has worked well

throughputs,” explains Giovanni Panzeri, automation project leader at Cama.

It was Cama's experience with the global automation supplier's independent cart technology (ICT) that helped seal the deal as well as providing the all-important physical link into the rest of the production line.

“Cama was one of the first companies to deploy the iTRAK ICT in a customer application,” Panzeri explains, “so we already had a good grounding in its operation and how it could be leveraged to deliver the additional flexibility many end users require”. Using iTRAK, with

its near limitless motion profiles, the individual product carriers within Cama's machine, controlled by the central PLC, are pitched automatically based on the width of the product or product groups that require insertion into the cartons.

Thanks to this, the cartoner can work intermittently or continuously depending on the product and throughput required at any one time.

A vital element of this installation was the way in which the CL 175 integrates with the downstream assembly processes, so as not to cause any bottlenecks. This, as it turns out, was

made possible using another Rockwell Automation ICT technology, this time the MagneMotion Lite.

Preceding the CL 175 cartoning machine, the Calvary Robotics line comprises three assembly machines, a product-printing module and two testing stations, arranged in a ‘U’ shape. All of the assembly and testing steps are interlinked using the MagneMotion ICT and so the MagneMotion technology was extended into the packaging operation.

“Thanks to the complete integration and the holistic control environment, having MagneMotion as the in-feed supply solution was a straightforward proposition,” Panzeri explains. “The Allen-Bradley control architecture delivers seamless interactions across all elements of the line, as if it is one large machine, so our packaging solution was simply another step in a larger process.”

T 01793 831111/831481

W www.camagroup.com

Four Delta robots are handling vol-au-vents with delicacy, accuracy and speed in Italy

Sfoglia Torino's vol-au-vent cases are so popular that when the company needed to meet higher volume demands, it decided on a robotic solution to speed up the packaging of three different sizes of product (38mm, 50mm and 60mm) direct from a conveyor into thermoformed blister packs.

An early challenge identified at the Italian plant was how to pick up (from the top) such a delicate product, and one which has so many variations in its finished

shape. Especially with such high volumes passing through at high speed every hour.

CONVEYOR TRANSPORT

As the vol-au-vent cases leave the ovens, they are transported on a wire mesh conveyor into a cooling chamber before going on to be packed for dispatch. The packaging station downstream of the cooling section is essentially a cabin housing the conveyor and four Kawasaki YF-03N Delta

robots, each equipped with some interesting vacuum gripping devices that lift the individual vol-au-vent cases three at a time with precision and also speed.

A vision system monitors the positioning for pickup and placement into the adjacent blister packs, and the complete system has proved to be a significant enhancement to Sfoglia Torino's productivity.

T 01925 713000

W www.kawasakirobot.co.uk



Picking vol-au-vents is made simple

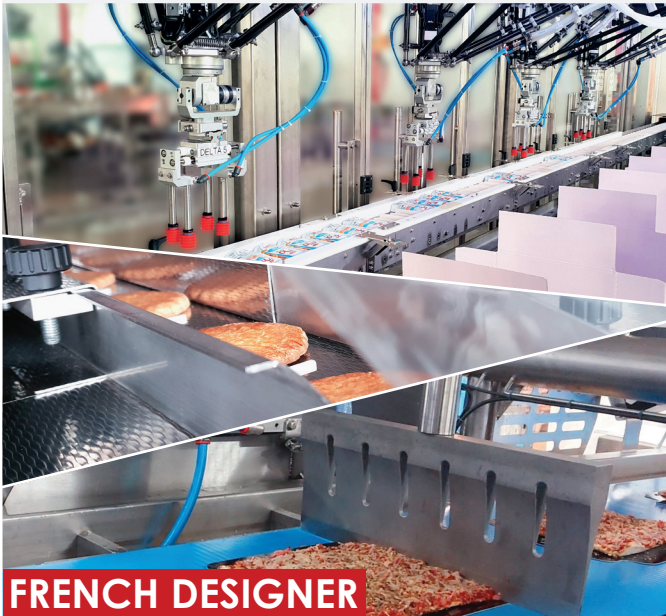

**FRENCH DESIGNER
& MANUFACTURER
OF PACKAGING LINES**

**Weighing
Labelling &
Control Range**

**Ultrasonic
Cutting
Machines**

**X-Fold &
Flow Wrapping
Machines**

**Sleevers
Cartoners
Case Packers**

**End of
Line
Equipment**

**Complete
Turnkey
Solutions**

CONTACT

info@ixapack.com
+33 549 820 580



www.ixapack.com

MEET US

all4pack
Paris

23-26 NOV 2020 PARIS | FRANCE

IMPROVE FOOD PRODUCTION LINE EFFICIENCY

High pressure washdowns

SKF Food Line hygienically designed bearing unit



High Humidity

SKF Food Line stainless steel deep groove ball bearing with solid oil



High shock loads

SKF Stainless steel Food Line bearing units



0800 8766 441



enquiries@acorn-ind.co.uk



www.acorn-ind.co.uk

SKF

acorn[®]
industrial services limited

Authorized
Distributor

Installation News

Manual handling process keeps to the correct temperature range

CKF Systems was commissioned to automate a process within the Rick Bestwick Chesterfield facility to reduce the manual handling requirements of its blast freezing process, increasing safety and also streamlining all the processes.

The temperature-controlled storage company receives palletised cases from customers in a chilled condition which require blast freezing for storage. To allow efficient blast freezing there has to be a suitable airflow through the entirety of the pallet, but on receipt the cases are palletised one on top of the other allowing no airflow between the layers. Previously this meant operators had to manually remove cases from the inbound pallets and place them onto a new pallet, inserting freezer spacers between each layer.

This was an extremely time consuming, manual task, with cases frequently reaching



The CKF designed system uses an ABB IRB 660

weights of up to 25 kg and the layer cards also being large and unwieldy.

Using an ABB IRB 660 robot and a series of vision systems, CKF developed a new system that automatically detects the position of cases on the

pallet in both the vertical and horizontal planes. A system was also developed to identify the position of the layer cards on a pallet or within the storage to accurately and repeatedly position the robot suitably.

Using a single tool, the robot picks and places full and part layers of cases, slip sheets, eggshell freezer spacers, UK standard pallets and Euro pallets. In operation, the

system initially receives a pallet, stripped of all pallet wrapping into the system. It then automatically detects the height of the pallet, position of cases and whether it is a full layer on the top of the pallet or a part layer.

The robot places an empty pallet in the palletising position, followed by a slip sheet directly onto the pallet and then picks the complete layer from the pallet and places it onto the pallet, ensuring position and skew of the layer is corrected (in the case of a part layer, the robot will place these cases to one side temporarily).

Once the cases are placed onto the pallet, a freezer spacer is placed onto the cases and the operation repeated until the donor pallet has been fully moved across with freezer spacers between each layer. Any part layers will then be placed onto the top of the new pallet.

After the pallet has been through the blast freezer, it is then de-palletised and re-palletised so that the freezer cards are removed from the pallet while product is then placed on a wooden pallet and a slip sheet for storage and shipment.

T 01452 728753
W www.ckf.co.uk

Automate with Confidence

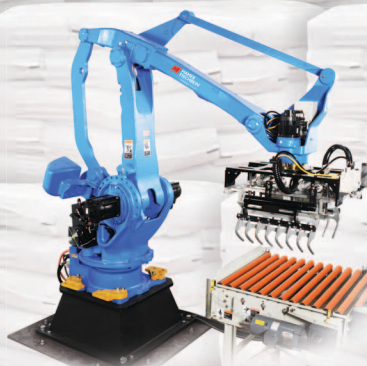

High Speed Robotic Palletiser



Materials Handling Solutions



Model 1200BH Open Mouth Bagger

- Automated Systems
- Superior Performance
- Innovative Design
- Advanced Technology
- Dedicated After-Sales Product Support

FISCHBEIN

A DURAVANT COMPANY

www.fischbein.com
sales@fischbein-saxon.co.uk
Tel: 020 8344 6600

Soup cooling facility upgrade delivers volume increase need

Thermal process solutions provider Holmach has installed a NIKO raining water tunnel cooler for hot-filled product in a soup manufacturing facility when this long standing customer needed to promptly merge sites and rapidly increase production volume.

Site space constraints were a particular challenge and so NIKO designed the new 20-metre long tunnel to be slid on top of an existing NIKO machine to allow for a 'double deck' operation. A leg support structure that was able to support the new deck while still allowing full access to the existing lower tunnel was also designed and installed.

ENERGY COST SAVINGS

Featuring a patented pump design, the unit offers savings of 50% of the energy costs compared with off the shelf pump/motor combinations, says Holmach. Delivering double the flowrate means that good temperature distribution across each deck is guaranteed. Chilled water is used to rapidly lower the temperature after filling and the cooler features a double skin construction allowing insulation, again concentrating on energy optimisation.

Pasteurising and cooling tunnels can be constructed to any size and with multiple zones, specific temperatures can be set and held for any desired thermal process.

The German company specialises in difficult to handle products such as gherkins, lemon slices and half cherries which present challenges when moving across stainless filling tables and on weighers.

T 01780 749097

W www.holmach.co.uk

NEW COBOACCESS™_PAL

14KG CASE PAYLOAD

**SAFE &
COMPACT**

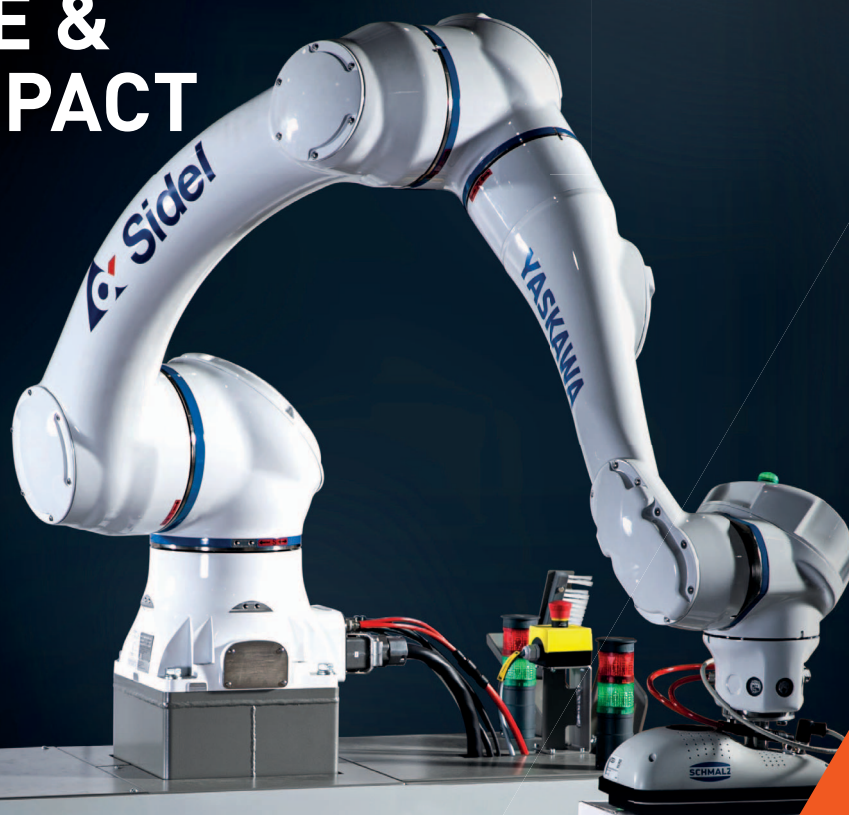

Cobotic Palletizing to transform working conditions. The perfect industrial fit for low speed lines!

sidel.com

Performance
through
Understanding

 **Sidel**

Installation News

Processing project has provided greater and consistent efficiency

Sycamore Process Engineering has completed a new yogurt manufacturing facility for family-owned farming and dairy company Yeo Valley. The facility will enable the company to produce its new Super Thick Kernald Yogurt and deliver greater levels of efficiency and consistency.

“The new capability that this project has delivered was an important step for our business,” explains Colin Hingley-Price, head of project delivery at Yeo Valley. “Having Sycamore as one of our major partners has been key to delivering this project to a high standard within a tight timescale.

“They have worked with us collaboratively to provide an exceptional processing facility that will produce high quality products for years to come,” he says.

The project, which kicked off a year ago, has many complexities and systems which needed to flow seamlessly and work together

to produce the final yogurt to the right quality and viscosity. The plant needed to have the ability to process a significant volume of product per hour to enable the Somerset based dairy company to keep up with increased demand.

This facility includes the installation of insulated cream holding tanks; a new pasteuriser; a new CIP system built to the latest customer codes of practice; large conical bottom yogurt storage tanks complete with gate agitation, designed to gently handle and not damage the product; various mix-proof valve manifolds; tubular heat exchanger skids for controlling the CIP temperature and a platform linking access to all of the main components of the plant. All of this equipment was



Sycamore’s process installation at Yeo Valley

designed, manufactured, and commissioned by Sycamore Process Engineering.

“Sycamore have been instrumental in not only the design, manufacture and installation of the new process plant, but also to provide advice and experience within their field and I look forward to working with them again on further projects,” says Hingley-Price.

A core component of

the project was to increase energy efficiency when it comes to yogurt production. The pasteuriser and ultra-filtration plant both include a regeneration system which recovers heat used during the process and saves energy by not requiring as much steam and chilled water. This makes the design very



Equipment is producing this product

effective and efficient, says Sycamore. Meanwhile, all aspects of the operation are optimised to minimise product, water, chemicals, heat, and service losses which was achieved by trimming interface volumes back of both product and CIP streams.

T 01963 441405

W www.sycamore.uk.com

Optimum efficiency for the confectionery sector is offered by weighing and inspection solutions, including software

Sula, a producer of hard and soft candies, relies on weighing and software solutions from Minebea Intec to deliver the shape, taste and consistency of its products in a variety of packaging formats.

The company uses the Synus dynamic checkweigher which is designed to offer reliable measurement results even at high process speeds and ensure that packs are ejected if they are outside the legally prescribed tolerance. In addition, the checkweighers



The Synus checkweigher in action at Sula

can regulate upstream filling systems via the integrated control, should overfilling or underfilling of the packs

become apparent.

The Synus checkweighers were developed in accordance with hygienic design guidelines to simplify cleaning processes. Their technology, menu navigation and design are geared towards simple and flexible changes in the production line so that a changeover to new or seasonal confectionery products can be implemented easily.

“The dynamic technology and ease of operation are the cornerstones of our system,” says Franz-Josef Laumann, Sula plant manager.

The Minebea Intec software SPC@Enterprise is also used by Sula to monitor all its devices. The data collected ensures complete traceability, among other things for audit, while Sula can review it to evaluate and improve overall line performance.

T 0121 779 3131

W www.minebea-intec.com



- **Stainless steel conveyor systems**
- **Standalone units or fully integrated**
- **Robotic and end of line equipment**
- **Bespoke engineering capabilities**
- **Turnkey and standalone solutions**
- **Integration and project management**
- **Service support and upgrades**
- **Partnered with Lita Palletising Systems for over 30 years**



www.kensal.com

sales@kensal.com | tel: +44 (0) 1 582 425 777

Kensal Handling Systems Ltd, Kensal House, President Way, Luton, LU2 9NR

Installation News



The Comau MATE exoskeleton

Wearable device is a safer option

Comau's MATE exoskeleton was chosen by IVECO to reduce the fatigue on the upper limbs suffered by the operators engaged in the heaviest activities inside the various production departments at its Brescia plant.

For employees working on the interior construction of minibuses, the company wanted a guarantee of the best operating conditions as part of its World Class Manufacturing (WCM) philosophy.

"We considered different types of exoskeletons, but Comau's MATE immediately stood out as the ideal solution for our needs," explains Paolo Gozzoli, WCM plant support at IVECO.

"First of all, we required a tool which could help our operators in activities involving the upper limbs without reducing their mobility due to its structure or size," he says. "Another crucial feature for us was our conviction that a wearable device should be easy to wear and lightweight, also considering summer heat as a detrimental factor in terms of comfort. And according to the operators using Comau's MATE, it is very easy to wear and like carrying a backpack that just needs a few initial settings to be immediately operational. Adjusting the shoulder straps is also quick and easy, which is really important, because the MATE is shared with other operators on the line.

T 01788 554500

W www.comau.com

Palletising system copes with freezing conditions



Vertical elevation at the end of each line maintains access and handling of all the materials at the bakery in Belgium

Scott Automation has designed and built a fully automatic palletising system for a renowned Viennoiserie producer in Flanders, Belgium that has coped with the demands of its cold chain while reducing labour costs at the bakery.

Since the installation, production output has increased by over 15% with improved line efficiencies and fewer line stoppages while also benefiting from reduced product damage and rejects, reduced packaging material costs through greater accuracy of stacking and reduction in board quality. Improved pallet load stability, reduced internal pallet and fork truck movement and reduced supply chain returns have also resulted for the baker.

One of the main challenges of the project was not to interrupt the cold chain required for the frozen bakery products and so two high capacity palletisers, in combination with accumulation zones in the freezer, ensures that this objective is achieved. The Moeskroen factory has six production lines located

at different points around this established site, with limited space at the end of each individual line. The baking and freezing processes are continuous and extremely time critical, so process stoppages are costly, detrimental to quality and time consuming to clear up.

The packing operations take place at ambient temperature, with a frozen product, which is extremely temperature sensitive. Any new solution needed to handle multiple case sizes with complex layer patterns, case weights up to 15 kg, occupy as little space as possible and offer flexibility.

VERTICAL ELEVATION

Following the brief, the Alvey Scott team developed a solution based on vertical elevation at the end of each line to maintain access and handling of the materials. Case transport at high level utilises unused factory space and brings cases to a central buffer area within a minus 25deg C cold store to protect the product.

Alvey's clever high level buffering solution means the product can be kept at a safe

temperature. In operation, and while building up a full pallet load, the buffer system enables continuous production and far fewer stoppages when compared to any directly coupled solution. The tables themselves are designed to run without any operator interventions and to be virtually maintenance free, which is ideal in such a cold environment.

Once a full pallet load is ready, cases are transported back out to ambient temperature and automatically palletised on one of two Alvey palletisers. Each palletiser has been rated for extra capacity and product flows can be switched to either unit depending on availability. Each palletiser has access to five different customer specific wooden & plastic empty pallet de-stackers and can apply multiple inter-layer sheets without disrupting production.

To protect the product, palletisation is continuous, with completed pallets being wrapped, labelled and delivered back into the cold store in under 5 minutes.

T 01384 210278

W www.scottautomation.co.uk

INTRODUCING THE NEW RAPTOR COMBI METAL DETECTOR & CHECKWEIGHER

NEW RAPTOR COMBI



FORTRESS
TECHNOLOGY

sparc
SYSTEMS

THE ONLY SUSTAINABLE INSPECTION
SYSTEMS WHICH SAVE YOU MONEY AND TIME

GUARANTEED.

- METAL DETECTOR
- CHECKWEIGHER
- X-RAY

CALL FOR 7 DAY DELIVERY

T +44 1295 256266

www.fortresstechnology.co.uk www.sparc-systems.co.uk

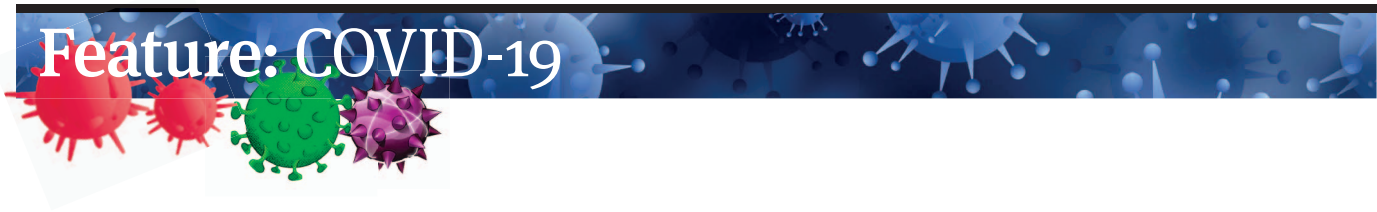

Safer working now delivered

PPMA member companies have spent this year devising clever ways to help UK manufacturers

CCOVID-19 has made everyone change their ways of working, and this has been especially true for PPMA member companies trying to install, service or maintain processing and packaging equipment at their customers' manufacturing sites throughout the UK.

At the beginning of C-19, when food factories were trying to meet unprecedented demand created by panic buying, there was a need for engineering support to keep factories running at full pelt. There was often also a need for new tooling to cope with different packaging formats due to pack rationalisation and also the complete shutdown of the hospitality sector.

These services were sometimes delivered by more engineers on the ground, but often remotely, most of which was needed in double-quick time, when end users were also screaming for hand

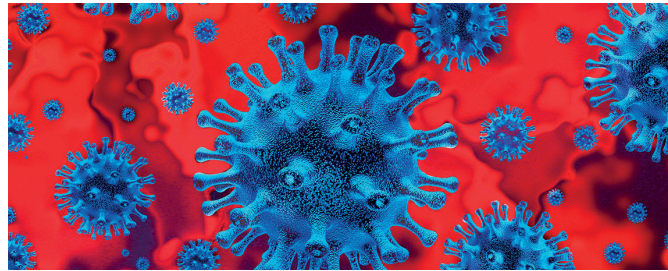

The global pandemic has brought about speedy changes across sectors

sanitisers and, of course, when there was a chronic lack of PPE.

As things have moved on, remote services are also now being offered for other things such as workshops, routine maintenance and for FATS. Other services such as more flexible pricing options, new products such as touch-free door openings and special door handles, along with protective screens for factory workers have all now been devised.

There's also a raft of thermal or infrared imaging options available today, there are uv-equipped mobile robots, there are new people-counting sensors and sensors for automatic hand sanitisers

There have also been many installations of wrapping, cartoning, bagging and pouch making machinery for face masks, as well as face mask-making equipment and mask folding units being designed. Fillers for hand sanitisers, disinfectants and anti-bacterial wipes have also been selling well, while many PPMA members have also been helping to manufacture PPE themselves.

All of these stories are covered in this feature which has been put together as

a way of helping manufacturers to either keep their factories efficient, upgrade their processes or change their ways of working due to self-distancing guidelines.

And with the C-19 outbreaks in

food factories becoming more and more of an issue, you could argue that the need for better ways of working have never been greater.

As the great philosopher Plato once said: 'Necessity is the mother of invention' and on the next 29 pages you will find a host of new technologies, products, services and installations that have resulted from the global pandemic, many of which are simple and cost-effective solutions.



green
GLUING



NEW APPLICATION HEAD

Smallest installation dimensions, fast and highly precise hot melt application
www.robatech.com/speedstar-compact



swiss
QUALITY+

GLUING SOLUTIONS ROBATECH



Adelphi Manufacturing

Response Filling Machines for Hand Sanitiser & Hygiene Products

- Exceptional filling accuracy of +/- 0.25%
- ISO certified, award-winning UK manufacturer
- Configurable for use in ATEX Zone 1 Category IIB 2G c T5 (100C)
- Suitable for liquids, gels, oils, creams, pastes and scrubs with particulates

Find out more about our full range of filling machinery, including ATEX:
www.adelphi.uk.com +44 (0)1444 472300 info@adelphi.uk.com



THE ONE STOP SUPPLIER FOR FLEXIBLE PACKAGING.

The new FLX HUB is where the production of all machines in the flexible packaging chain converge.

Everything needed to process all types of flexible packaging for the Food, Pharma, Wet Wipes and Pet markets is right here.

The full array of leading technologies brought together in one facility, where a one-stop supplier drives the quest for excellence, sustainability, constantly researching innovative solutions and new eco-compatible materials.

IMA FLX HUB. Flexpect more.

www.ima.it



Feature: COVID-19

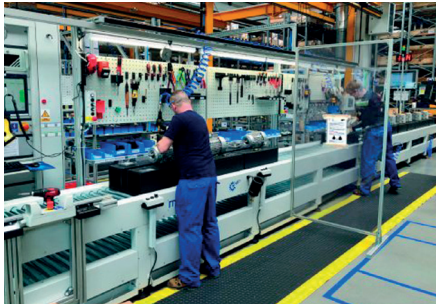
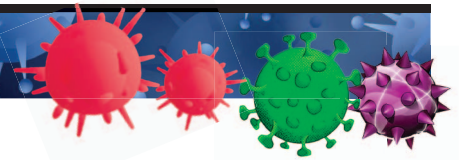

Partitions between the workplaces in assembly

Drive technology deliveries continue at a reliable pace

Nord Drivesystems has kept up its delivery availability throughout the pandemic with production, logistics and service continuing to operate as usual due to its international network of local production and assembly facilities.

Measures to protect production and the supply chain have been joined by precautions to protect the employees at its plants. These include the contact-free change of shifts, extensive hygiene measures, including compulsory wearing of masks and keeping safe distances, as well as a safe workplace design. This includes transparent partitions between the workplaces in the assembly area with all personal tools.

Furthermore, the company is pursuing its investments as planned pre-COVID. Currently, Nord is expanding its production and assembly capacities in China, Poland and in the USA. A new automated small parts store is also being built at its Bargteheide headquarters.

T 01235 534404
W www.nord.com

Engineers are at C-19 sharp end

PPMA members have relied on their technical experts to cope with the relentless workloads

Lockdown has had a profound effect on many businesses, especially those trying to keep the nation fed during the first panic-buying days of the coronavirus pandemic.

For instance, Engelmann & Buckham's engineers such as Ian Fairbanks, who has worked for the company for seven years, was on the frontline throughout lockdown. "We had to deliver engineering to some sites that are over three hours away from home, normally we would stay overnight and continue working the next day," he said. "During lockdown, we had to commute long distances, work all day and do the same again the next day."

These sentiments are echoed by Luke Murphy, director at GIC. "Machines on-site required attention and we were facing a backlog of installations, particularly in food production, so the

team was run off its feet," he said. "I think the biggest challenge for us was finding accommodation and subsistence if our engineers were required to stay overnight," he continues. "One engineer, in particular, was away from home a lot as they supported customers."

G Mondini UK invested in its service and support teams during lockdown with new technicians and technical co-ordinators recruited to help manage the additional demand and volume of incoming service support requests. This facilitated rapid local deployment of engineers to increase customer support and maximise machine up-time.

In addition, the company experienced an increase in the demand for tooling, to fulfil the temporary requirement for increased pack sizes across multiple packaging applications. Increasing its UK-based tooling-stock meant it could offer a quicker response to requests.



simmatic
AUTOMATION SPECIALISTS

BRINGING PNEUMATICS AND VACUUM TOGETHER

Vacuum Conveyor

- Dustless conveying of your dry powder or granular produce
- Convey food materials, pharmaceuticals, chemicals, plastics and other free flowing granular products
- Clean, safe compressed air driven multistage vacuum pump, pre delivery atex approval upon request 
- Low maintenance with self-cleaning filtration, yet high level of capacity from 0.6 TPH to 6 TPH



VMECATM
www.vmecca.com

Simmatic Automation: VMECA product specialist and UK agent for 15 years. Vacuum challenges? Simmatic has the solutions



Expertise – Passion – Automation



Industrial robot and cobot solutions from SMC

SMC produces compact and lightweight automation components for robotics applications and End-of-Arm tooling.

We offer a wide variety of products that can be used for handling work pieces of different shapes and materials. These include: **Pneumatic, Electric and Magnetic Grippers, Compact Cylinders, Vacuum components and Fieldbus Systems.**

If you're looking to automate some of your manual applications with industrial robots or cobots, we have the experts that can help you!

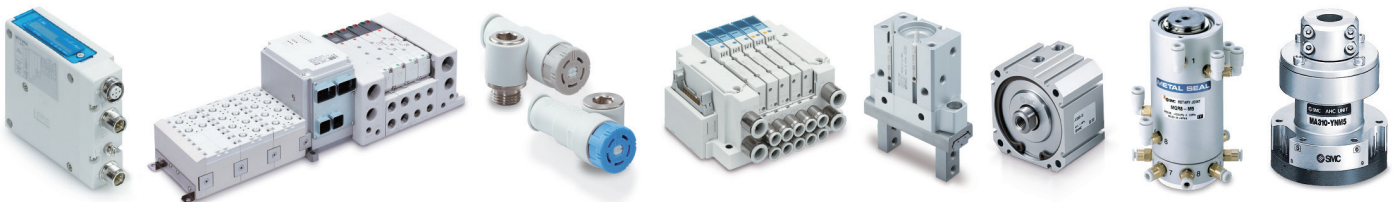

Call 01908 563888 or check-out our website.

SMC - more than just pneumatics

Follow us on   



www.smc.uk



Hygienic handles are making door opening, safer...

ifm electronic has used the skills and expertise of its development team – which usually works on the company’s industrial sensors – to devise a novel door handle adaptor that reduces the risk of virus transmission. The adaptor makes it easy for doors to be opened by pressure from an elbow, rather than by using the handle in the usual way, which involves touching it with the hand.

After testing the new adaptors in its own factories and offices, the company has now repurposed part of its injection moulding facility to produce the adaptors in larger quantities and make them generally available.

Moulded from durable and easy-to-clean high-grade plastic, the adaptors can be fitted in seconds to any round door handle with a diameter between 20 and 22 mm. No drilling is needed, there is no risk of damage to the handle and the adaptors can be removed just as quickly and easily as they are fitted, should this be necessary.

“Like most companies, we wanted to make a contribution to the control of the coronavirus,” said Rob Birkett of ifm electronic, “so our team of first-class designers, who knew that door handles could be a breeding



ifm’s handle adaptor is very easy to fit



Handling is super clean

The new handle is available in nine colours: green, red, beige, orange, blue, black, grey, white and yellow

ground for pathogens, came up with the idea for the new handle adaptor.

“So, less than three weeks after our designers had the initial idea, we now have the adaptors in full production, and we can offer fast deliveries for anyone who wants to purchase them.”

STOPPING THE SPREAD

Meanwhile, OEM is selling Conta-Clip’s new HYDH hygienic door handle. When the coronavirus crisis struck, the team first focused on protecting the health of their employees and safeguarding critical supply chains. Then they set themselves the task of contributing to the fight against the coronavirus with the HYDH hygienic door handle being a simple and effective device that helps prevent the spread of infection.

With the HYDH you don’t have

to use your hand to open a door, you can use your elbow or your forearm. It’s quickly and easily attached to an existing door handle and no tools are required. These handles are suitable for a wide range of different door handles, can be mounted on both left and right-hinged doors and tamper-proof clamps are provided to protect against theft.

Each packaging unit contains one hygienic door handle with two tamper-proof clips, an illustrated manual and a self-adhesive label.

Moving onto the shop floor, Efaflex is now offering ‘touch free’ door opening at a distance from 5 cm to 40 cm. The latest ‘Clear View’ is a non-contact switch using microwave technology that is designed to replace push buttons to reduce the risk of any bacteria.

www.ifm.com/uk

www.oem.co.uk

www.efaflex.co.uk



NO HALF MEASURES

Full production safety and efficiency for the confectionery industry

Whether for weighing products or detecting foreign objects, our technologies ensure reliable processes along the production and packaging line. However, product safety and quality are only one side of the coin. If, at the same time, manufacturing productivity is raised to a new level, our weighing and inspection systems reveal their full potential for you.



Find out more!

WEIGHING &
INSPECTION
SOLUTIONS
IN GERMAN QUALITY

Minebea
intec
The true measure



Combi-Checkweiger Cosynus®



Weighing module Novego®



Industrial scale Combics®



Software SPC@Enterprise

Feature: COVID-19

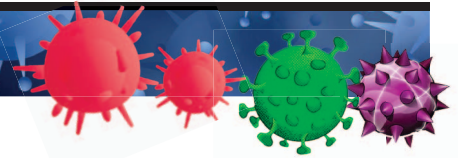

Washdown range has improved hygiene for users

Lafert Electric Motors has supported essential businesses in the food, beverage, medical and pharmaceutical sectors through what has been; in some cases; their busiest times, particularly with its Marlin stainless washdown range of motors, gearboxes and IP66 inverters.

Due to customer demand and expectations in these sectors, the company remained fully open and stocked throughout lockdown and says it has managed to keep up its high level of support and fast turnaround.

“This has been critical to many companies for whom reliability and continued production is vital and in the case of the Marlin stainless range, where conventional motors may cause issues either through failure from ingress, or from a hygiene perspective,” explains Brian Bannister, managing director at Lafert. “We have been able to maintain our high level of on-time deliveries and order fulfilment of motors for mixers, pumps, conveyor systems and all manner of food and pharmaceutical processing lines.”

This range is available in many cases for next day delivery:

- Stainless steel IP69K/IP66 electric motors up to 22kW
- Stainless steel gear boxes, worm, helical bevel with or without brake
- IP66 inverters for washdown applications – IP55 or IP20 are also available.

T 01270 270022

W www.marlinstainless.com

Robots disinfect range of spaces

Omron and partners have devised a disinfection solution with its latest uv-equipped mobile robot

The need for additional hygiene procedures during COVID-19 has ignited new fields of application for robotics for disinfecting various spaces including mobile robots mounted with ultraviolet (uv) light attachments. The automation of disinfection with uv light improves health and safety, thus contributing to the fight against COVID-19 with mobile robots being ideal for uv lamp use, which are not safe for humans to operate.

The new Omron LD 60/90 autonomous mobile robots are ideal for disinfecting various areas, as unlike traditional AGVs, they navigate by the natural features of the facility and require no expensive facility modification. Safety lasers and sonar allow the robots to detect obstacles in their path to prevent collisions. Multiple mobile robots can operate within a facility as a fleet thanks to the company’s fleet management software.



Automation is used for disinfection processes

“We have now adapted our uv technology to help our UK customers during the pandemic to treat enclosed spaces with the same uv light,” explains John Kane, technical manager at Topline Electronics. “In choosing to use the Omron LD mobile robot, our company can move the proven uv technology around customer spaces easily.”

T 01908 258258

W www.industrial.omron.co.uk

Lantech® Packaging Machines & Service

Lantech modular case erector capable of up to 25 erected cases per minute

- All new erector pick up frame
- Ergonomic magazine for easy filling of case blanks
- Small footprint
- Easy size change from one format to another
- Supplied as a hot melt glue option or adhesive tape
- Colour operator touch screen panel
- Can be a stand-alone machine or integrated into other machinery
- Installed and commissioned with after sales support
- Linear style case erector

CI 1000/CI 2000
case erector
from Lantech



A.M.J. MATERS
Packaging and palletising systems

17 Elizabeth Court, St Neots, Cambridgeshire, PE19 8PF

T: 01480 382739 M: 07764 772965 E: andrew@maters.co.uk www.maters.co.uk

Freshly-Launched Fuji Flow Wrapping Equipment to Complement the Alpha 8 Series

NEW

▶ **Fuji VXII** for produce manufacturers

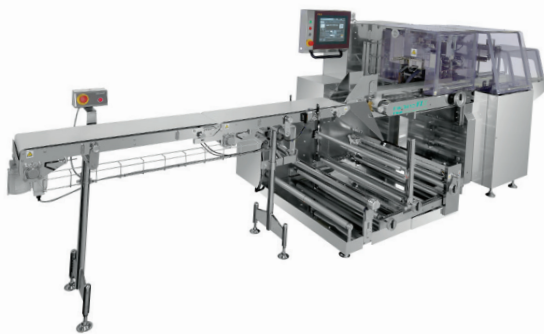

▶ **Fuji CXII** for bakery manufacturers



- Flexible
- Energy-efficient
- Operator-friendly
- Compatible with recyclable, biodegradable & compostable films
- Simple product changeover
- Easy maintenance
- IH centre sealers, maintenance-free, using 20% less energy than traditional mould heaters

▶ **Book a virtual demo with our technical team**

Call **01252 815 252** or email fuji@paramount-packaging.co.uk

PACK STYLES

3 side seal

4 side seal

Reclosable

Shrink

Flow bag

Block bottom gable top

Linked packs

Pillow

Gusseted



Feature: COVID-19



50,000 units of hand sanitiser a day is filled

Lines were supplied in eight weeks

Karmelle has answered the need for increased demand for hand sanitiser by designing, manufacturing, installing and commissioning two lines for a customer in just eight weeks.

The company supplied two turnkey bottling lines to West Yorkshire contract packing specialists Lquipak which has enabled it to fill, cap and label 50,000 units of hand sanitiser per day.

Lquipak was contracted to pack the sanitiser for a market leading hygiene brand that needed help to meet unprecedented demand as a result of the COVID-19 pandemic. The Lquipak team reached out to Karmelle, whose engineers recommended two complete filling, capping and labelling lines to deliver these increased volumes.

The two lines were designed and manufactured in Karmelle's Huddersfield facility.

Line one comprised a 4 head 1 litre filling machine, a 4CT capping machine, and a front, back and wrap labelling system. The second line featured an identical capper and labeller but a larger 8 head filling machine. Both lines were delivered to the contract packer within a couple of months which has been appreciated by the customer.

"Karmelle pulled out all the stops to ensure that the equipment was up-and-running as quickly as possible," explains director at Lquipak Simon Dickinson. "Their engineers have also been on hand to provide aftercare and support," he said.

T 01484 533356
W www.karmelle.com

Mixing it up for hand sanitisers

The entire range of mixers from **Silverson** have been supplied for hand sanitisers worldwide

Silverson Machines has supplied a number of machines to customers for the manufacture of hand sanitiser products including laboratory scale, pilot scale and full production scale batch mixers since COVID-19 began. A special unit normally used for the production of sauces was sent over to Malaysia for instance, assisting in the attempt to reduce transmission of the virus by using hand sanitisers, as well as showing the flexibility of the mixing equipment.

Another customer, a gin distillery in the UK, was able to pause its gin making and quickly begin producing hand sanitisers thanks to Silverson. As part of the fast delivery service offered by the company, it was able to quickly supply the distillery with a Flameproof Batch mixer so they could begin production. In this instance a Flameproof ATEX motor was specified as the hand sanitiser solution contained 80% ethyl alcohol.

There are a number of active ingredients used in hand sanitisers, but the most effective sanitising products are based on alcohol, usually isopropyl or ethyl alcohol. The alcohol is blended with an aqueous dispersion of carbomers such as Carbopol, to provide the gelling effect. Although Carbopol makes up a very small proportion of the overall formulation, as with many powder/

liquid applications, it has its own set of processing problems that can sometimes be exacerbated by conventional agitators.

Carbopol is a low density powder which tends to float when added to water, requiring vigorous agitation to be incorporated. Carbopol also tends to form agglomerates when added to water, and a conventional agitator is unable to break these lumps down and fully hydrate the powder. This leads to poor yield, long mixing times, poor consistency and variations from batch to batch.

To overcome these problems, many manufacturers are specifying high shear mixers for this application.

The high speed rotation of the Silverson rotor/stator workhead forces the powder directly into the high shear zone, rather than allowing it to float on the surface of the liquid. Any agglomerates that may have formed are immediately broken down in the gap between the rotor and the stator.

Once the carbomer is fully dispersed, the alcohol phase is added. Silverson In-Line mixers allow this via a manifold at the inlet of the mixer, ensuring that two phases are mixed immediately on contact.

As well as providing mixing equipment for hand sanitiser applications, Silverson has also created a 'How to' video and application report on hand sanitisers. The video demonstrates how Silverson high shear mixers can effectively disperse the Carbopol used in the formulation to then guarantee an homogeneous product, batch after batch.

T 01494 786331
W www.silverson.co.uk

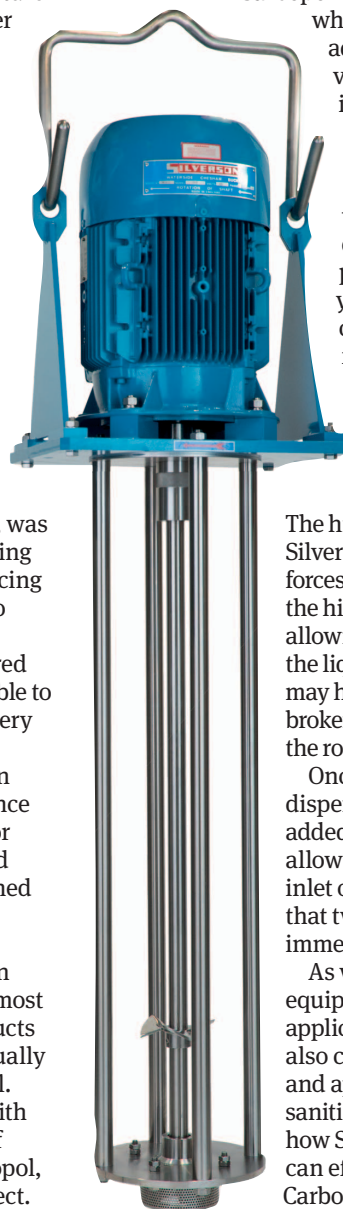

The Silverson GX batch mixer has been in demand

Expand the possibilities for autonomous material transport

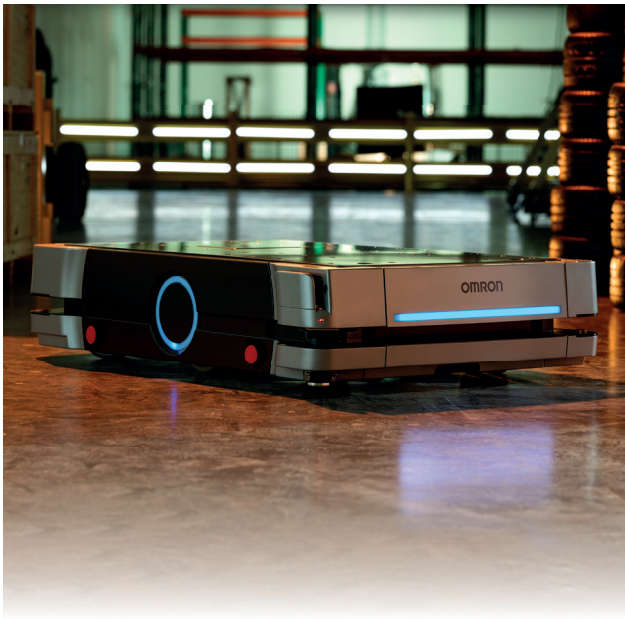

New HD-1500 Mobile Robot from OMRON with 1500kg Payload Capacity

The 1500kg payload capacity of the HD-1500 from OMRON enables transportation of large automotive components such as car chassis and voluminous pallet size payloads - items that would have traditionally been moved using forklifts.

Control up to 100 mobile robots with different sizes, configurations and payload capacities under one system to automate complex material transport and logistics applications with OMRON's industry-first Fleet Manager.

+44 (0)1908 258258
 @ oeeuk_sales@omron.com
 industrial.omron.co.uk

Contact us for proof-of-concept testing!

• Great value • Small footprint • Fast changeover times • Robust



Packaging Machinery Supported by UK Based Engineers

- Specialists in pre-made pouch machines, stickpack and sachet machines, form-fill-seal and pillow pack machines
- Serving the food, medical, pharmaceutical, cosmetic and technical industries



Watch our Machinery in Action



Side Spout Pouch



Side Gusset



Stand Up Doy



Paper Pouch



Centre Spout Pouch



Sachet



Stickpack



Flexible. Scalable.
Adaptable.

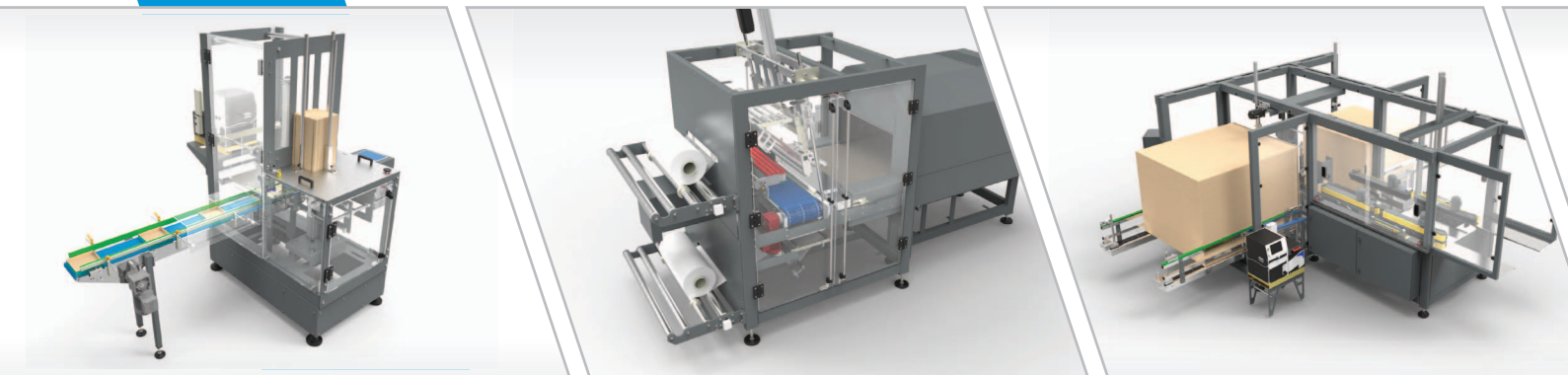

See our online exhibitor listing
at www.ppmashow.co.uk



While you navigate a rapidly evolving business landscape, WestRock is fully operational and prepared to serve you. Whether you need a single case erector, robotic solutions, a complete integrated system, or something in between, WestRock Automation provides a range of secondary transit packaging equipment tailored to solve your unique challenges. Please reach out and let us know how we can support you.

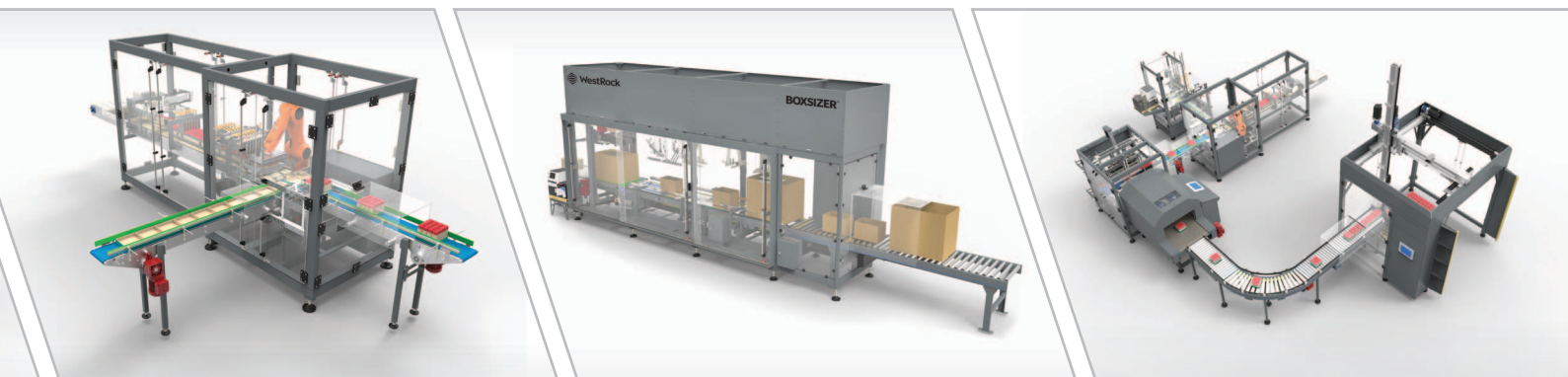

KUKA

Official System
Partner

Platinum

westrock.com/automation-uk • aps.uk@westrock.com



Supplying quickly with a special price

With quick turnarounds from order to installation, remote VPN assistance and payment options to suit different businesses, Multivac's large product portfolio of packaging and processing machinery were readily available to keep critical food production and medical supply lines running during lockdown.

"At the start of lockdown in March, one of our customers faced a catastrophic failure on a second-hand machine they had previously purchased from a dealer, resulting in the complete stoppage of one of their critical food production lines," says Phil Crozier, business development manager at Multivac. "Within 72 hours, a new machine was installed, and the customer's production line was up and running again."

The company has also been able to supply FRITSCH bakery equipment, including the ROLLFIX dough sheeters and cutting tables, at a special price aimed at artisan bakers needing to upgrade or replace existing machinery during these difficult times.

T 01793 425800

W www.multivac.co.uk

Online Workshops are tailor-made

Phoenix Contact has created the option of a bespoke online workshop which demonstrate how the company can help users create and maintain a competitive edge.

These Phoenix Contact Online Workshops are tailor-made for individual requirements and held in an individual



Workshops offer benefits

Microsoft Teams meeting to cover topics such as cabinet optimisation, cloud-based energy management and also robust communication.

T 0845 881 2222

W www.phoenixcontact.co.uk



Protective screens with stainless steel frames and clear plastic sheeting are protecting workers

Hygiene needs are met, easily

Unitech Engineering has answered requests for bespoke COVID-19 secure hygiene solutions...

During the last five months, designer and manufacturer of hygiene equipment Unitech Engineering has been swiftly turning around requests from customers requiring answers to COVID-19 problems.

One such request came from a major convenience food manufacturer that needed a new solution to meet social distancing requirements for its employees working along production lines in close proximity. Unitech therefore designed, manufactured and installed protective screens with hygienic stainless steel frames and clear plastic sheeting to protect workers along five of the manufacturer's production lines.

These screens were then later adapted for another customer who had requested a portable option for its manufacturing plant. The frames were fitted with castors and designed to fold in multiple ways for versatility and easy storage.

The company already supplies a wide range of sinks, but it has since adapted the design of its wash troughs, usually

supplied with knee operated or sensor operated spouts, to be wand operated following a request from a client. The units were also adapted to incorporate Dyson wash and dry spouts making the hand cleaning and drying process fully contact free.

One customer requested a wash unit for use outdoors to allow delivery drivers to wash their hands upon arrival and on exit from its site.

NEW PPE CLEANING STATIONS

Unitech has also developed PPE cleaning stations in response to the current situation which were required at a large poultry processor to ensure workers were protected from splashback from other workers while washing. Each cubicle is separated by a stainless steel partition and the unit can be easily and quickly washed down after use.

Unitech also offers bespoke hygiene entrance equipment, including boot wash machines, barrier railing and hand sanitising turnstiles.

T 01543 675800

W www.unitech.uk.com



Markem-Imaje presents:
INNOVATION DAYS 2020
October to December

More than 30 online events

- Track & Trace Solutions
- End-of-Line Solutions
- Packaging Intelligence
- Brand Protection
- Laser Solutions
- Software Solutions



Register to receive the full schedule!
info.markem-imaje.com/innovation_days_registration

Feature: COVID-19

Helping everyone to distance safely

Sick UK has developed a couple of SensorApps that help people keep their distance at work and in public

Responding to the need for technologies to slow the spread of COVID-19, Sick has developed PeopleCounter and DistanceGuard SensorApps which help to ensure that people keep to the recommended distance apart in working and also in public spaces.

The PeopleCounter is a SensorApp based on a machine learning algorithm running on the company's MRS1000 3D LiDAR sensor. One or more sensors can be easily set up to count people at entry and exit points or allow users to control the number of people occupying a

pre-defined area in real time. Because the system can reliably detect human contours, while ignoring other objects, customers or workers are counted accurately as they enter or leave buildings or other pre-defined spaces.

ON-BOARD ALGORITHM

The PeopleCounter works by using a specially-developed on-board algorithm to evaluate the point-cloud data generated by the MRS1000. Because the SensorApp can use data from the MRS1000's four 275 degree scanning layers to determine direction of movement, the number of people in a monitored area can be updated in real time.

The system can identify more than one person in parallel independent of their direction (in or out) within a range of up to 3.5 metres.

As it only sees the human outline, the PeopleCounter is able to process data at high-speeds and is completely anonymous with no need to detect or record any personal location or identification data.

Meanwhile, Sick's Social DistanceGuard App works on the TiM 2D LiDAR sensor to monitor areas where the recommended distance between people must be upheld and provide an alert if they are too close. A signal, in the form of a light, audible alarm, or visual signal is



People numbers are monitored

triggered as soon as the distance between two people falls short of the minimum.

The on-device settings can be used to input or change the required distance at any



The Trusted Metal Conveyor Belt Manufacturer™

Enhanced Hygienic Conveyor Solutions



Flex-Turn® Conveyor



Ladder-Flex™ Conveyor



Straight Conveyor

- NEW open leg frame
- NEW simplified wash through design
- Easy to clean & maintain
- High density blue plastic components

Wire Belt Company Ltd, Castle Road, Eurolink Industrial Centre, Sittingbourne, Kent ME10 3RF
 Tel: +44 (0) 1795 421771 | Fax: +44 (0) 1795 428905 | Email: sales@wirebelt.co.uk | www.wirebelt.co.uk

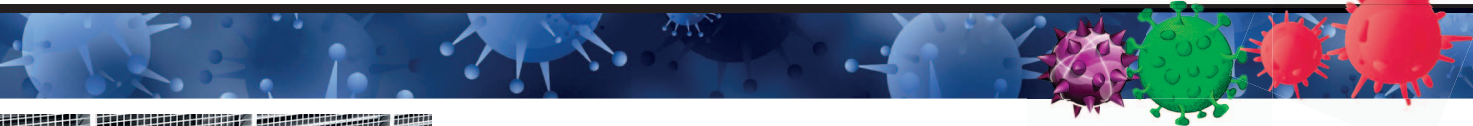

solutions,” explains Sick’s UK product manager for imaging, measurement and ranging, Neil Sandhu.

“When combined with

Sick’s programmable, high-performance LiDAR scanning technology, the result is simple, self-contained devices that are quick to install,

and easy for customers to integrate into wider customer control or monitoring systems.”

T 01727 831121

W www.sick.co.uk

cap coder

UK MANUFACTURED PACKAGING MACHINERY EXCELLENCE

Turnkey solutions – Filling, Capping, Labelling – Automation – Bespoke, special purpose design

Pharmaceutical – Food and Beverage – Chemical – Aromatherapy – Medical –
Diagnostics – Industrial – Ecig – Adhesives

- ▶ Fully modular machinery
- ▶ Clean room ready
- ▶ Latest interface technology
- ▶ Full after-care service

time. The presence of people can be detected and evaluated thanks to the TiM’s 270 degree scanning capability and range of up to 25 metres.

“Our rapid response to develop social distance monitoring technologies was enabled by the versatility of the AppSpace software development platform that facilitates the rapid development of plug-and-play



The sensor helps in self distancing

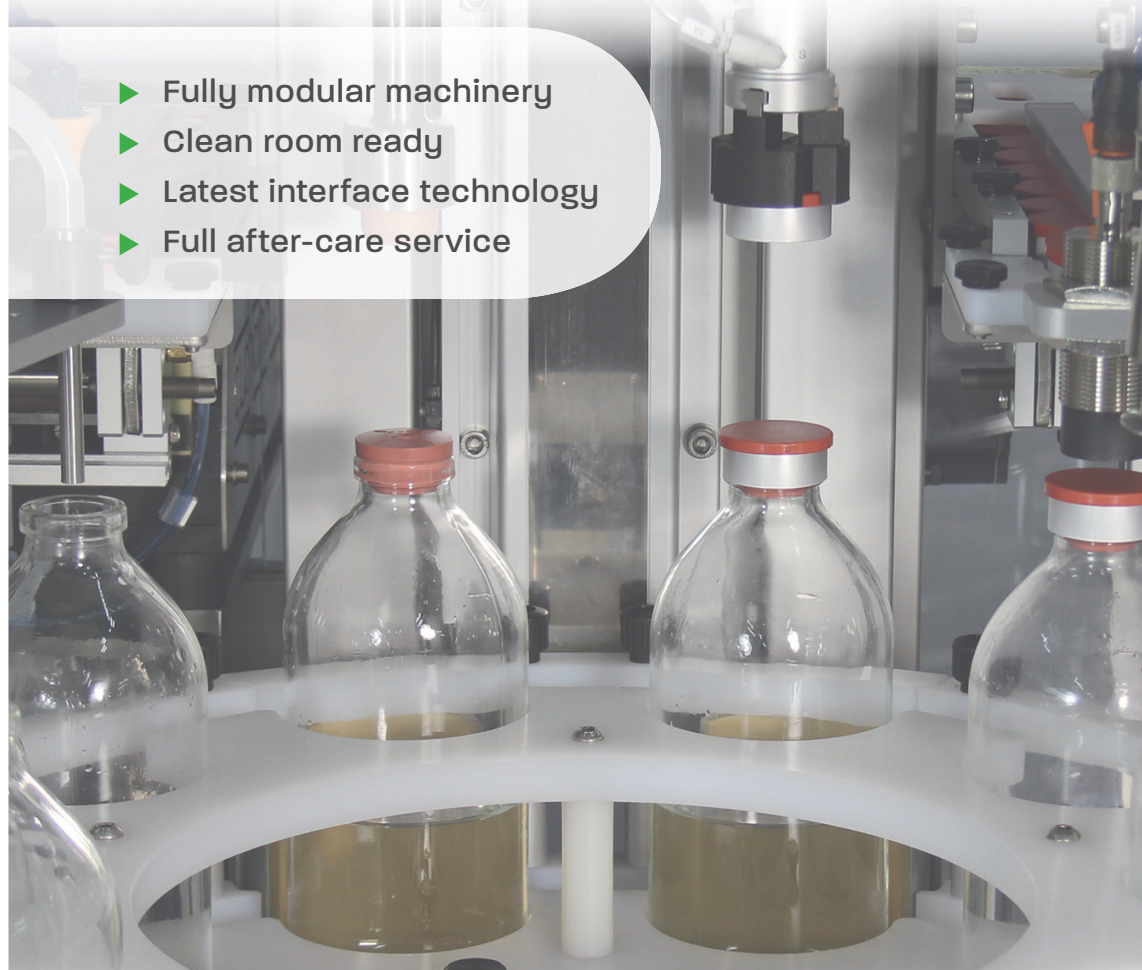

To discover more about the machines that could transform your company please visit:

www.capcoder.com

Tel: 01865 891466 Email: sales@capcoder.com





Turnaround was quick for wrapper

PFM Packaging Machinery played its part in a co-ordinated effort to help a new customer get vital, life-saving medical equipment to the NHS frontline quickly for use in the battle against COVID-19.

A UK specialist manufacturer of respiratory products for critical, perioperative and neonatal care turned to PFM for the first time when it desperately needed to expand its packaging capacity to meet with surging demand for ventilator tubing, it was supplying to hospitals, to assist the breathing of patients who had contracted the coronavirus.

Fast turnaround was the key factor for the manufacturer, especially with the challenge of travel restrictions in place due to lockdown – PFM UK had the ideal equipment in stock at its Leeds facility, the Pearl flow wrapper. A thermal transfer coder for labelling was also required, which was supplied and installed quickly by Clearmark Solutions.

After receiving samples of the product for packing, PFM's engineering team prepared the Pearl to the required specification in a company-record time. Videos of procedures for installation and operation were supplied that enabled the customer's staff to get the machine up and running on site very quickly, with just a couple of phone calls for guidance.

"The Pearl was in stock and is simple to operate and so after receiving the samples we were able to send a video to the customer demonstrating the machine wrapping its products," explains PFM sales and operations director Chris Bolton.

www.interactivecoding.co.uk

www.pfmuk.com

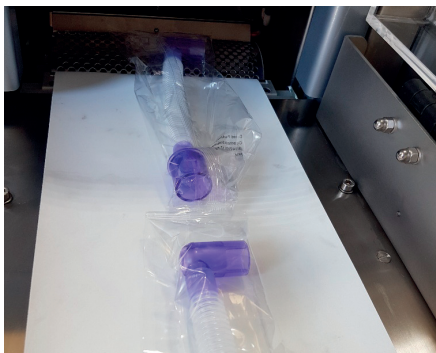

The machine was set up in record time by PFM



Tristel™

"I didn't need to look elsewhere," said Tristel's Peter Twelftree on placing his latest order

Flexible fillers deliver gains

Tristel Solutions automates disinfectant filling with four more benchtop fillers from **Adelphi**

Tristel Solutions, a global manufacturer and supplier of infection control, contamination control and hygiene products, has invested in four new Response benchtop fillers from Adelphi to keep up with demand for its disinfectant products in recent months.

The four new fillers were supplied in April and brings the company's total up to 10. With production up as much as 50% in some instances, the machines are all filling the two key disinfectant products which Tristel has geared its production to, in response to the coronavirus outbreak. These include Distel, a fluid for cleaning and disinfecting hard surfaces within hospital environments, and Jet, a powerful sporicidal disinfectant, with proven effectiveness against SARS-CoV-2.

Tristel is also now running the Response Automation Base with four individual benchtop fillers. "The Response machines have really come into their own," says Jenny O'Callaghan, production manager

at Tristel. "We're able to incorporate the Response's into our automatic line or use them manually as production requires," she said.

The new machines arrived within four working days of production engineer Peter Twelftree's order being placed; "they were up and running quickly," he says. Despite seals having become damaged in transit when the first two of these new machines were shipped, Twelftree remembers that "Adelphi got the replacements shipped out quickly along with our second two machines, and packaged them differently the second time, so no more damage occurred."

When asked whether he had considered using any other machinery suppliers to help Tristel meet their increased production demands, Twelftree said: "I like the Response machines, I wasn't worried about looking for someone else as they're reliable and not temperamental."

T 01444 472300

www.adelphi.uk.com

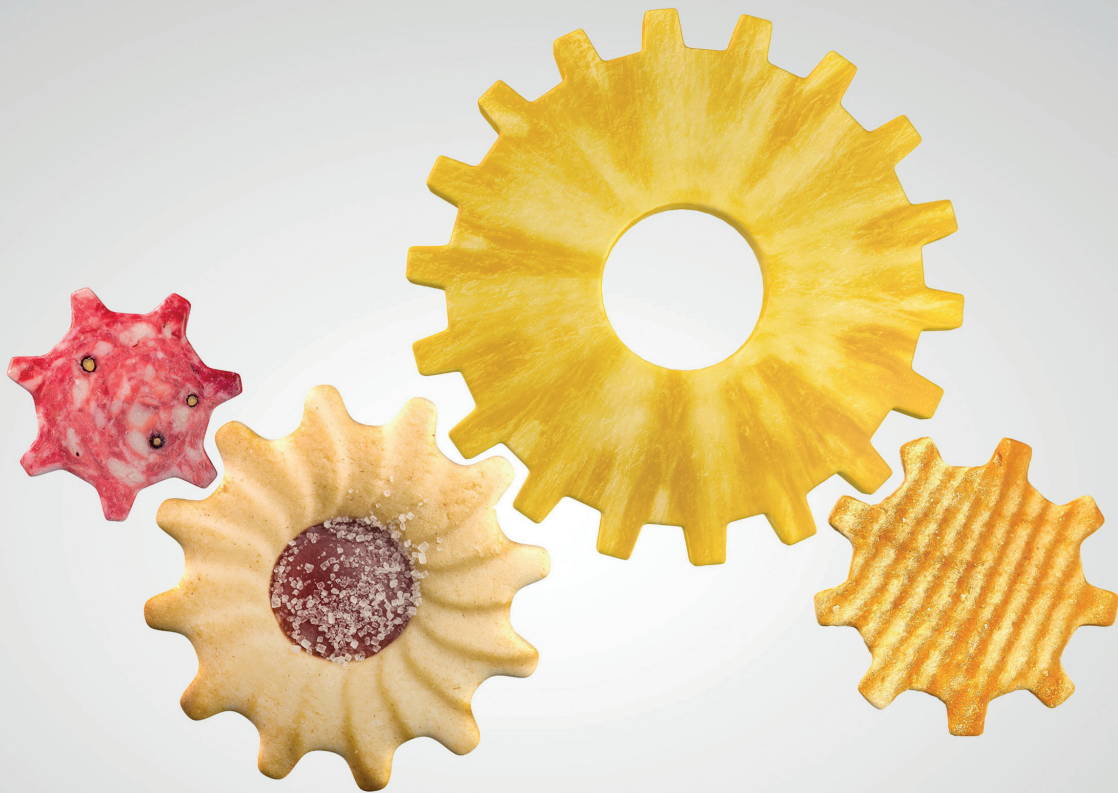

Retail ready. Smarter, faster, together.



Every business has its own challenges; ours is to help you overcome yours. If you need to improve productivity, we can help you produce more, in less time. If accuracy is an issue, we can help you get back on target. If you need to adapt to higher standards, we'll help you raise the bar.

Smarter Faster Together

► To set the wheels in motion visit ishidaeurope.com



Largest manufacturer of stretch wrapping equipment in the world

MACHINERY

UK aftersales spares and service support provided.

Turntable Wrapping Machines



Self-Propelled Robot Wrapping Machines



Horizontal Wrapping Machines



Rotating Arm Wrapping Machines



Case Sealers & Erectors



www.robopac.co.uk

Robopac, Unit 7 – 8 Highfield Parc,
Highfield Road, Oakley, Bedfordshire, MK43 7TA

Tel: 01234 825050 Fax: 01234 827070 Email: sales.uk@robopac.com

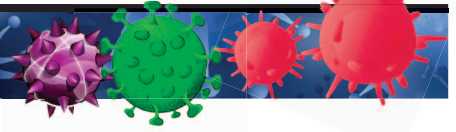

Safe clamping

Elesa's clamps make safety screen making easier

The Elesa Panel Support Clamp range offers a quick and robust solution to the construction of safety screens manufactured in acrylic or other materials that are beneficial in managing COVID-19 infection risks in the workplace or public areas. These clamps enable simple assembly of divider panels such as 'sneeze screens and shields' for industrial safety enclosures, guarding of machines or workstations.

Also, easy installation of protective panels onto industrial frames in steel



The clamps enable simple assembly of 'sneeze screens and shields'

or aluminium extruded sections is provided.

This range has been extended with the PPR series in black or

grey, for plain panels between 4 mm to 6 mm, or for wire mesh as an aid to ensuring compliance with machine safety requirements such as ISO 13857 para 4.2.4.

They are suitable for architectural panels and similar, such as stair panels, partitions, balconies and more. Clamps can be fitted to standard 1 inch square tube without drilling and come with or without internal vibration damping rubber grip pads for plain panels, or with locking teeth to suit electro-welded mesh type TEC (maximum wire diameter 3 mm). They are constructed in tough glass reinforced polyamide with flush mounted M5 AISI 304 stainless steel fittings for a quick and simple clamp-in-place installation.

T 01526 322670

W www.elsa.com

SIMULATE, AUTOMATE AND PLAN FOR WHAT'S NEXT!

With VISUAL COMPONENTS 3D manufacturing simulation technology.

Visual Components empowers users of all skill levels to virtually design, optimize, and validate their production systems **in a risk-free, virtual environment.**

The key applications of the software are:

- Layout Planning
- Production Optimization
- Virtual Commissioning
- Robot Offline Programming
- Virtual Reality

Find out how you can save time, reduce costs, and improve production performance with our solutions. Request a free product demo at www.visualcomponents.com.

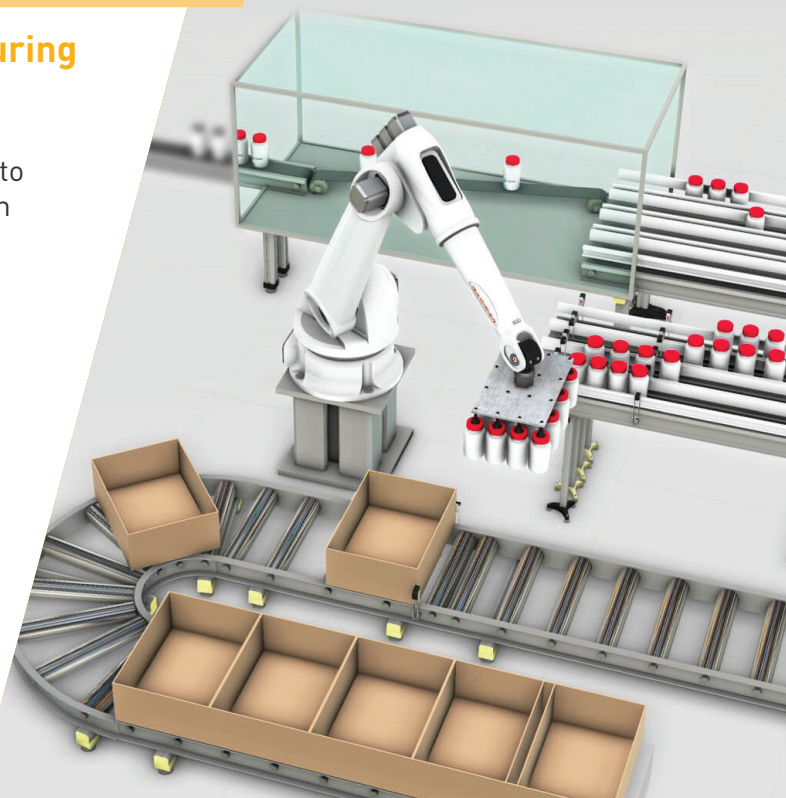



Drum clamp attachment for high care

New to Packline Materials Handling is a vertical drum lifting clamp attachment with powder coating that is suitable for pharmaceutical and also the medical processing industries.

This lifting solution was designed in response to a pharmaceutical customer working on coronavirus products that needed to lift drums of chemicals to



The drum lifting clamp in action

and from a weighing scale, in a clean room high care environment. The clamp attachment has been specifically designed to handle drums and similar vessels by providing powered vertical lifting and lowering only, without any drum rotation. The drum clamp arms have a powdered coating with a blue plastic coating to prevent

contamination of the ingredients or the chemical contents of the drums being lifted at any time.

Meanwhile, the clamping mechanism is fitted with a torque limiter so that the gripping pads do not over or under tighten on the external diameter of the drum. In addition, a pair of proximity sensors can be fitted to the attachment to control the maximum opening and minimum closing positions; this feature is helping to minimise any wear on the mechanism.

This new lifting equipment has a maximum capacity of 225 kg however director of Packline Teresa Winter tells *Machinery Update* that larger capacities are available on request.

All of these features combine to enable an operator to lift, transport and handle the drums with complete confidence.

T 01202 307700

W www.packline.co.uk

Cartoner meets mask volumes

Cama's side-loading cartoner has met current needs while also adapting for future demands

A recent plant-upgrade project for one of Cama's UK customers couldn't have come at a more important time. The customer, a major science and technology company that supplies a multitude of market-leading products to both industry and consumers, needed to replace a 20-year-old packaging machine to significantly boost throughput on its line.

"The incumbent machine, which is used to pack face masks, was creating a bottleneck in the production line," says Mark Brooker, director of Cama UK. "Our customer needed to take its packaging throughput up to 400 products per minute, from its current level of 300.

"Even though the on-site engineers were highly capable and had already overseen multiple machine enhancement projects on other elements of the line, this two-decade old machine really had maxed out its potential and needed to be replaced," he continues. "As it turns out, the engineers on site really liked our proposal," Brooker elaborates, "and they realised that our CL179 machine would not only fit the physical space, but would also blend and integrate very well with the existing technology – in terms of both its hardware and software. We were also able to offer a wider variety of options and could deliver multiple proof points of these machines in action in similar applications around the globe," he said.

The Cama CL179 side load cartoning machine is well suited to non-woven products such as face masks, where it is

already serving customers, handling soft-compressible materials, such as those found in feminine hygiene products as well as cosmetic and baby wipes.

The company's CL horizontal cartoning machine series has been developed and continuously improved to offer high-performance and reliable solutions for side-loading applications. In this application, the machine delivers high speed, pocket based in-feed solution where products are fed either as single elements or pairs (depending on the product type). The products are gently compressed individually before being compiled into the packaging counts, where they are compressed once again before being inserted into cartons, in boxes of 20 or 40. Switching from single valve-equipped masks to double arrays

of basic non-valve masks takes a matter of minutes.

"The machine is tailored to this application in the fact that it has a leaflet insertion



Cama UK has supplied a CL179 cartoner to pack face masks at higher speeds needed

and verification solution, which is unusual for these types of machines," Brooker concludes. "It also has in-built flexibility to cater for future performance upgrades, especially in terms of product throughput."

T 01793 831111 / 831481

W www.camagroup.com

Flow Wrap Challenge Accepted

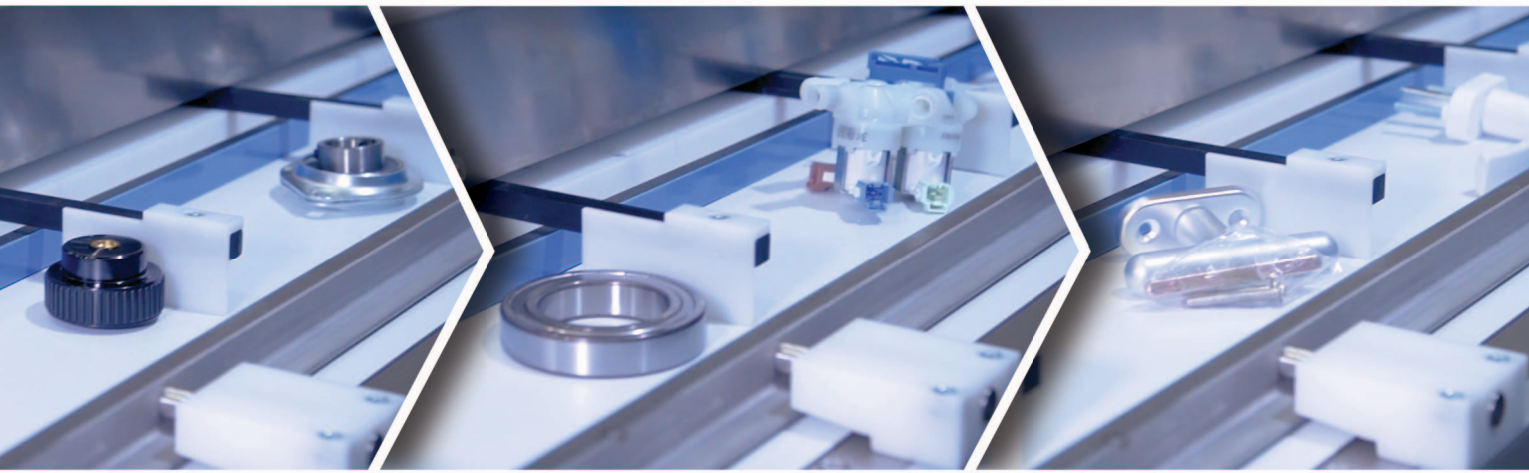

Unusually shaped products or materials are our forte. BW Flexible Systems' unique sealing technology is ready to handle your toughest Flow Wrapping assignments.



Locally Serviced and Supported

Our horizontal flow wrap solutions run film widths up to 1400mm, offer product-specific infeeds and automatic feeders, and interface with your other automated equipment.

Packaging Industrial and Non-food Products

- Pharma/Medical devices
- Plastic items
- Paper goods
- Personal hygiene
- Housekeeping supplies
- Chemical products
- Hardware and electrical
- Automotive parts

Even More Products:

- Insulating panels
- Aluminium, plastic, wooden profiles
- Dry ice
- Wallpaper rolls
- Welding electrodes

Hayssen | Rose Forgrove | Sandiacre | Schib | Simionato | Symach | Thiele

Feature: COVID-19

The global crisis in PPE supply earlier this year has seen a host of engineering skills deployed to try to tackle the issue

Antalis, for instance, launched a range of PPE solutions to protect people working in offices and warehouses and other commercial environments from COVID-19. Its protective face visors are made from a range of clear materials to ensure maximum hygiene and a high degree of clarity while disposable face masks are also available in a variety of materials and can be used in combination with these protective visors. Disposable aprons made from polythene are designed for single use to prevent contamination.

Clearmark Solutions utilised its engineering and design knowledge to produce and donate PPE face shields to local NHS facilities that were experiencing shortages. This has been achieved by utilising its 3D printing systems to print the new visor components. The systems were initially introduced by Clearmark to manufacture bespoke parts for the coding integrations systems, offering increased accuracy and manufacturing flexibility.

BESPOKE FACE SHIELDS

Now, alongside creating bespoke parts, these 3D printers are used to produce the mounts for PPE face shields, while Asmech Systems laser cut the clear Perspex part of the shield which attaches to the 3D printed mount.

During the crisis, Minebea Intec donated 50 protective masks to Royal Glamorgan Hospital in the fight against the coronavirus crisis and continues to donate masks to hospitals in need. It formed part of the company's European effort which saw the distribution of a total of 17,000 N95 protective masks around 17 European locations.



Disposable masks, face shields, visors, a flow wrapper and components that helped to create a mini face mask factory

Protecting the whole world

PPMA members have answered the call to make PPE from existing and new equipment and also wrap it...

The company said its responsibility was to protect not only its own employees, but also the local communities and regional economies.

Meanwhile in Italy, the Marchesini Group and the University of Bologna created a prototype that produces super filtering material for masks. It enables the production of filtration materials for face masks with greater protection against viruses and bacteria compared to materials currently in use. This new type of filtration material for masks is based on electrocharged polymer nanofibres.

And in the US, employees at Vortex designed and produced

cleanable, and reusable, face shields for the local hospital, Salina Regional Health Centre. In addition to the production of face shields, Vortex temporarily shifted from producing the Vortex Iris Valve to creating face masks for its essential employees. Sewing machines typically used to create Iris Valve sleeves were used to sew these masks.

In March, Intamac Packaging Systems began importing new mask-making equipment from the Far East. The IPS-KZ-N95 and IPS-KZ-1-2 mask-making machines were designed by its Chinese manufacturing partner and it has received unprecedented interest from businesses looking to adapt

and help the fight against COVID-19 in the UK.

Festo, too, has been offering engineering support for mask making equipment, by supplying electric and pneumatic components as well as software for a new containerised production facility that enables businesses and healthcare organisations to produce their own masks.

The mini factory uses a scalable system that can produce between 50-100 face masks per minute.

Electric and pneumatic components from Festo ensure the reliable transport of the parts or perform clamping tasks at every stage of the process, from the three-layer

unwinding station, to the shaping and folding station for the non-woven fabric, on to the ultrasonic sealing station for sealing the edges and finally attaching the ear loops.

When the crisis in PPE was at its height, Schib Packaging, a BW Flexible Systems' company, lent a CO-50 flow wrapper machine to an Italian-based contractor, at no cost, to package face masks destined to help combat the spread of COVID-19.

FREE OF ANY CHARGES

When a local business converted its production for textile-finishing products to making face masks, instead, the packaging machinery supplier didn't hesitate to help out. "Knowing the huge need for masks in Italy at that time, I didn't think twice," said Alessandro Stiffan, Schib's general manager. "We already had the availability of a Schib CO-50 machine which is a good fit for packaging face masks."

Meanwhile Screenworks, a company previously known for garment decoration in the promotions industry, has launched a new Bumpaa anti-viral facemask and snood which is treated with ViralOff technology. These products have been in high demand since inception which is why Friedheim supplied a Serienpacker S1750XJ from Beck Packautomaten within a week of the initial enquiry. This machine is capable of

the consistent high speeds necessary to bag 600,000 masks, it sets up quickly and can handle over 1,800 items an hour, says the company.

www.antalispackaging.com
www.buckham.co.uk
www.bwflexiblesystems.com
www.interactivecoding.co.uk

www.festo.co.uk
www.friedheimpackaging.co.uk
www.marchesini.com
www.minebea-intec.com
www.vortexglobal.com



HYGIENIC SOLUTIONS - FOR WASHDOWN AND ASEPTIC PROCESSES

THIS IS **SICK**

Sensor Intelligence.

The portfolio of stainless-steel sensors and accessories from SICK offers hygienic solutions for flexible automation, to protect machines and processes for quality control, and for identification applications. Use SICK stainless-steel sensors to ensure chemical resistance, thermal resistance, impermeability and structural design, while adhering to market standards. Install quality sensors that won't let you down.

We think that's intelligent. www.sick.com/hygienic-solutions



The new Bumpaa anti-viral facemask

Feature: COVID-19

Fever screening units explained

Here are three options for checking temperatures that are designed to help businesses keep open

It is said that for fever screening devices to be truly accurate, they have to measure the temperature of a person's Medial Canthus or tear duct region as it is generally accepted as a region that offers the closest correlation to the core body temperature. Another key prerequisite in determining whether a system is worth its salt, is the use of a 'black body' reference source.

As Dr John Dunlop, founder of Bytronic Automation warned in an open letter to industry in April, the margin for error in 'off-the-shelf' skin temperature software currently being rolled out could be up to six times greater than existing international standards allow. "Checking temperature readings of crowds of people tells you something and nothing at the same time," he wrote. "The margin for error could be up to three degrees, which in medical terms is the difference between good health

and a serious cause for concern."

Acrovision agrees and says that with so many offerings suddenly appearing on the market, potential buyers of such equipment should be asking themselves a number of questions about tear ducts, pixel resolution and black body reference source. Also, potential users should ask if the solution comes with a certificate of calibration.

Acrovision has launched the AFS-100 fever screening solution that it bills as reliable, accurate and versatile. It meets the ISO 80601-2-59:2017 standards for 'Basic Safety and Essential Performance of Screening for Human Febrile Temperature' and is designed to be easy to install and use, and yet remain ultra-accurate in its results.

The system consists of a high resolution thermal imaging camera, feedback monitor, plus the all-important 'Reference Box' that ensures the accuracy of +/-0.5deg C.



Medial Canthus

The tear duct region is important for screening

As an option, the AFS-100 offers a Data Collection bolt-on, which allows the use of Personnel ID cards to both trigger the camera and to log individual's temperature measurements for further analysis or tailoring of results. It is also worth knowing that Acrovision is pleased to say that 10% of the profits from AFS-100 sales will be donated to the NHS.

In designing the solution, Acrovision analysed what the market needed and what was required to ensure the system was 'fit-for-purpose' and gave the greatest chance of highlighting fever-like systems. In operation, the AFS-100 targets the Medial Canthus area; it analyses every pixel (approximately 1.3 mm) of this area and highlights the hottest region before

ALS Advanced Labelling Systems Limited



Label Printers • Label Applicators • Print & Apply • Complete Systems

+44 (0) 1844 213177

www.als-uk.com

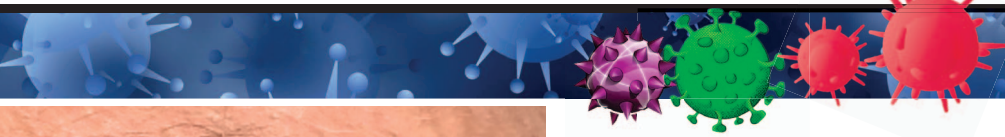

using a Reference Body to ensure the required accuracy, regardless of changing ambient temperatures.

Bytronic Automation's new elevated body temperature (EBT) detection system measures body temperature by scanning the area around the tear duct and is accurate to within half a degree centigrade, meeting existing international standards. High temperatures automatically trigger an alert, either on screen or through a light or sound alarm – with that result immediately recorded to a database, giving a highly accurate indication of a possible fever or underlying infection.

DISCREET INSTALLATION OPTION

This EBT system can be discreetly installed at existing barriers or building entrances and is fully compliant with existing ISO and FDA regulations.

"The launch of this system is one small, but vital, measure to help combat the spread of disease and get businesses back open," says Dr Dunlop. "We've combined Bytronic's HotSpot software with our experience of vision systems and thermal inspection to provide a screening solution that's highly accurate, meets all international standards and doesn't require a constant human presence."

To meet all agreed international standards for accuracy, the Bytronic EBT system scans the area around the tear duct and compares human body temperature to a fixed 'black body' temperature emitter within the same camera shot that is constantly re-calibrated, giving an accuracy level of between 0.3 and 0.5 degrees centigrade.

For accuracy, the EBT system will only scan one face at a time, not groups or crowds, and with glasses or eye coverings removed. It must be used with a high-resolution infrared camera with a minimum of 340 x 240 pixels, which can be included.

Micro-Epsilon has introduced the thermoIMAGER TIM QVGA-HD-T100 infrared camera which is supplied with a certificate of calibration that validates temperature measurements made against a traceable 35deg C temperature reference source (black body).

The camera is accurate to ± 0.5 deg C when used with the TM-BR20AR-TIM black body source, which means it can provide reliable skin temperature measurements for fever detection systems. It is ideal for integration into an automated monitoring system which can be used in real time at point-of-entry into establishments, to prevent people with elevated body temperatures entering.

THERMAL IMAGING CAMERAS

"The basis for the effectiveness of thermal cameras as a fever screening tool lies in the correlation of outside skin surface temperature with that of the internal or core body temperature," says Glenn Wedgbrow, business development manager at Micro-Epsilon UK.

"As a supplier of thermal imaging cameras, we are fielding many questions from existing and prospective customers with regards to their use as a screening tool for COVID-19," he says. "Although our cameras do not detect any specific virus or condition, they can be used to detect elevated body temperatures in humans, which may indicate a possible fever."

Individual screening is primarily used at controlled entrances and security gates. The Medial Canthus (tear duct) provides the strongest correlation between outside skin temperature and core body temperature and is measured more precisely from a close distance. This method is also best for detecting low grade fevers.

For this application, Micro-Epsilon recommends the thermoIMAGER TIM QVGA-HD-T100 infrared camera with 29 degree optics placed at a distance of 1 m from the target, or the same camera but with 13 degree optics at a distance of 1.5 to 2 m from the target. To achieve an accuracy better than $\pm 0.5^{\circ}\text{C}$ the imager must be combined with the TM-BR20AR-TIM Black Body Reference Source.

www.acrovision.co.uk

www.bytronic.com

www.micro-epsilon.co.uk

Hygienic drive solutions to suit **YOU!**



- Hose-down tolerant (tested to IP69K)
- Hygienic design and Clean-In-Place compatible
- No waste catchment areas and no flaking paint
- Worm and high-efficiency helical bevel gearbox options
- Application specific customisation available
- IP66 inverters available



LAFERTGROUP

Tel. 01270 270022
lafertuk@lafert.com
www.marlinstainless.com

Feature: COVID-19

The first challenge for Intamac occurred at the start of lockdown and the imminent arrival of an IPS-8BT stand up pouch machine urgently needed by a British co-packing business. A normal FAT would have taken place in Italy, but it quickly became obvious that this would be impossible. Instead, it was delivered to its warehouse in Petersfield, then given a deep clean before the UK engineers performed a virtual FAT.

Helping to install new and vital equipment at food manufacturers in lockdown drove the need for digital FATs at Engelmann & Buckham. Its principal Volpak has developed a streaming platform for a live FAT that allows interaction with the customer in real time with a number of remote FATs already successfully completed.

CHEESE CUTTING LINE

ixapack Global helped to set up a cheese cutting line remotely from its site for one of its customers in Eastern Europe. To achieve this, teams connected to the customer's network, but also directly to the new block cutter and two portioning machines, specifically with access to the different cells of the equipment.

Line commissioning was first carried out in empty mode, with the support of the teams on site for direct response by video to ensure the correct functioning of each station. Product was then introduced, and portions cut in variable weights very successfully.

AMP Automation has been incorporating remote access systems into its machines for several years, and the company believes it has never been more evident of how important it can be for all parties than in the last few months.

During the early travel restriction period, the



Intamac's Tom Poston says the delivery of this new pouch machine was definitely a more clinical sign off than usual

How remote can you get?

Travel restrictions have seen technical support being delivered remotely and here you can find out how...

company had a customer who had a problem with a machine installed overseas. To handle this, its remote service team accessed the software, found the problem and had the machine up and running very quickly. However, the line stopped again after only five minutes, and following a further fast investigation, a problem with a motor was identified. The error code showed the motor was overheating.

The time taken between the initial phone call from the customer to the new

motor being packaged and despatched by courier was just six hours. "This is a very quick turnaround, and a much faster scenario than someone flying out to another country to identify the problem," explains Adam Malpass of AMP Automation.

A STEP-BY-STEP GUIDE

Following its despatch, a simple step-by-step guide was sent to the customer showing how to calibrate the new motor within the machine. "While the customer was able to do this with the

guide provided, there was still the option of remote access by one of our service team members if needed," Malpass tells *Machinery Update*.

Other companies that have been actively offering remote services are OAL, who has begun offering remote training sessions, something that had only been carried out on-site previously; Ulma's Remote Services is a suite of tools designed to offer flexible packaging machinery servicing support and maintenance, with optimal efficiency and security in

mind, and many of Proseal's customers have taken advantage of the additional connectivity offered by upgrading their machinery to have an internet gateway installed. This allows Proseal engineers to remotely dial into the machine while speaking with the engineers on site.

Lots of PPMA member companies have also set up on-line showrooms. Minebea Intec, for example, now offers a digital platform for new and existing customers to visit one of their showrooms in a virtual space. Via an online video conference, interested parties have the opportunity to ask experts questions, see live product demonstrations and get the best solution for their individual requirements.

VIRTUAL DEMO SERVICE

At the same time, Endoline Machinery has introduced a new virtual machine demonstration service to ensure end-of-line machinery specifications are met exactly, without the need for face-to-face interaction, while Romaco has also set up a virtual showroom as well as harnessing digital channels for servicing and maintenance.

Flying in the face of all this remote interaction is Shemesh Automation, who managed to solicit the help of US Senator Ron Johnson to clear the path for some of its technicians to pass through the US border on a temporary basis to ensure all its US customers could be fully supported during the pandemic.

With manufacturers of disinfectant wipes and hand sanitisers urgently needing to

upscale production, Shemesh has doubled its engineering team as well as other departments, with an overall headcount increase of 35%.

www.ampautomation.co.uk
www.buckham.co.uk
www.endoline-automation.com
www.intamacmachinery.com
www.ixapack.com

www.minebea-intec.com
www.oalgroup.com
www.proseal.com
www.shemeshautomation.com
www.ulmapackaging.co.uk



Complete liquid packaging lines

Filling machines

Capping machines

Labelling machines

Atex machines

Servicing and spares

Liquid packaging systems, designed to help your business run more smoothly...

Ready to improve your liquid filling, capping and labelling operation? The first challenge is sourcing machines that work together seamlessly.

That's where Karmelle Ltd come in. Drawing on years of industry experience, our team will design a bespoke liquid packaging system to suit your product and processes. Each component - from highly efficient filler, to capping machine, automatic labeller, and conveying - is built entirely in our West Yorkshire workshop.

Once your line has been installed, we'll train your team and provide regular services - allowing you to focus on growing your business.

Call +44 (0) 1484 533 356 or email karmelle@gmail.com



Minebea Intec has virtual showroom

Karmelle Ltd Unit 17 Queens Mill Ind. Estate Queens Mill Road Huddersfield HD1 3RR
 t. +44 (0) 1484 533 356 f. (0) 1484 549 332 e. karmelle@gmail.com www.karmelle.com

Feature: COVID-19

Smart options are offered by **ABB**, **B&R** and **KEB**

ABB's Robotics and Discrete Automation business has launched a special package of digital solutions as well as virtual and field service support initiatives to help businesses restart production lines that may have been idle for weeks or months during the COVID-19 pandemic.

As well as helping customers to troubleshoot and fix issues related to robots and operations lying dormant, the offer includes several ABB digital tools to help customers optimise processes and be more proactive in maintenance activities, which will help reduce costs in both maintenance and production areas.

The company is also supporting its customers with a virtual consultation and audit to help identify issues and support needed and delivery of spare parts to ensure customers have the correct part in stock for a quick and effective restart to production and to minimise risks in the restart process. Alternatively, old controllers or manipulators can be upgraded to extend the life of installed robots.

"In addition to virtual training, field service teams and spare parts, we can help customers remotely monitor, troubleshoot and optimise entire robot fleets via ABB Ability Connected Services," says Sami Atiya, president of ABB's Robotics and Discrete Automation business.

Meanwhile, B&R Automation is offering continuous, secure monitoring of machine data from a distance. Through LogTunnel, a feature of the company's secure remote maintenance platform, machine builders can establish a continuous connection to plants and machinery in the field. With LogTunnel, data from machines all around the world can be archived in a central location and any irregularities in performance can be detected early to help maintain maximum availability.



Connecting smart gains

LogTunnel is a feature of B&R's secure remote maintenance solution, and it offers continuous, secure monitoring of machine data from a distance

The secure remote maintenance platform lets companies check in on plants and machinery anywhere in the world from an office or on the go and users can even take control of equipment if necessary – as if on site. Through continuous data logging, LogTunnel allows faulty components to be detected early and service intervals to be optimised. Setup is a simple matter of drag-and-drop and requires no special IT know-how. The platform functions in accordance with all the latest IT and cybersecurity guidelines, says the company.

SECURE REMOTE ACCESS

Another option for maintenance comes from KEB. It has introduced a hardware and software solution that provides users with a fast, secure remote access maintenance platform for industrial machines and automation systems.

This concept of remote maintenance

offers many advantages and opportunities, including not having to expose employees and customers to unnecessary risks – which is a particular challenge in the current global coronavirus pandemic.

Remote maintenance can remove the need to travel to machines or plant equipment and therefore saves time and travel costs. Technical experts can also provide support more quickly. Remote maintenance solutions make it easier to access devices from a different location, for example, during commissioning, maintenance work, troubleshooting and machine status analysis.

COMBIVIS connect from KEB is a fast, secure remote maintenance platform that ensures optimal service conditions in modern automation systems.

www.abb.com

www.br-automation.com

www.keb-uk.co.uk



universal
FILLING MACHINE COMPANY

Pound Lane, Kingsnorth
 Ashford, Kent, TN23 3JE U.K.
 Telephone +44(0)1233 643666
 Email: mail@universalfilling.com
 Website: www.universalfilling.com



Universal Filling Machine Company would like to thank customers old and new for your continued support this year and we look forward to seeing everyone at the PPMA Show in 2021

Universal solutions for filling & capping



Specialists in Filling, Flexible Packaging, Secondary Packing & Automation



STAND UP POUCHES



CONTAINERS

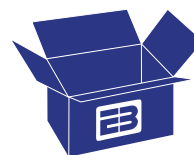

CARTONS AND CASES



ROBOTICS



SACHETS



BOTTLES



DRUMS



IBCs

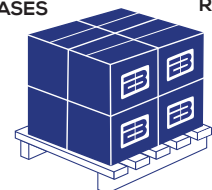

PALLETS & AUTOMATION

Feature: Sustainability introduction

Adding to the green debate

While **coronavirus** has delayed some packaging eco goals, the drive for sustainability remains

With the long-trailed Plastic Packaging Tax and Deposit Return Scheme being put back until 2023, people are asking if the sustainable packaging effort can survive Covid-19? Whatever the timescales however, there is no doubt about the important role that packaging equipment manufacturers can play in the continuing drive for more sustainable packaging solutions.

Equipment manufacturers are working on power consumption reductions, lower compressed air usage, switching to central vacuum systems, and using less material to wrap products, to name but a few. Sustainable goals are definitely on the table in terms of NPD, as our feature on pages 62-63 illustrates.

But while new pack styles that reduce the amount of materials being used, including more recycled content, are being developed, they still need to

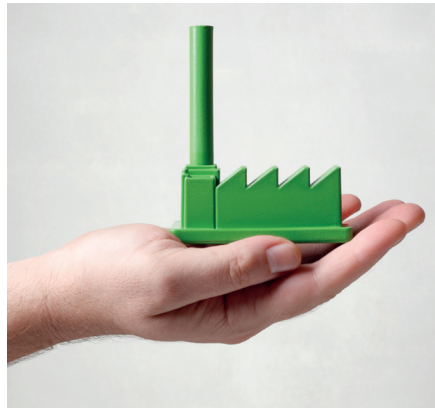

Sustainable developments are reported across this feature as well as eco opinions from Tesco

be handled reliably and speedily on packaging equipment.

Another element that always needs to be in the mix is food waste, not just packaging waste. “Packaging materials

and equipment can contribute to the reduction in food waste through various technologies,” says Torsten Giese of Ishida Europe. He highlights the company’s developments in modified atmosphere packaging, its leak detection equipment called AirScan and x-ray inspection units.

As the new Ecodesign Directive comes into force throughout Europe in the summer of 2021, the energy efficiency of standard asynchronous motors, in particular those designed for continuous operation, will have to continue to improve. To make this transition, Lenze has started to compile some basic information, as well as a checklist, for OEMs and machine operators.

Lenze is also launching a new motor platform with the m500 series, while an intelligent web-based planning and conversion tool is also on the cards. The company has set itself the goal of making the switch to the new m500 motor generation as easy as possible for its customers and to further optimise the machine with its consulting services in one fell swoop.

One thing Domino Printing Sciences says is that ease of recycling can present an opportunity for manufacturers when it comes to thinking about a coding solution, particularly when coding with inks. “While some new sustainable packaging materials in the form of recycled plastics, paper and compostables can prove challenging from a coding perspective, recycled food and beverage cans have been part of the equation for years,” says Russell Wiseman, head of global beverage solutions at the company.

Fully Automatic Stretch Wrapping Solutions from YPS & TOSA



- ✓ Turntable, Rotating Arm & Rotating Ring models available
- ✓ Solutions for high speed or high stretch requirements
- ✓ Low maintenance, High performance
- ✓ Designed to reduce film consumption
- ✓ Included Service Contract with every machine

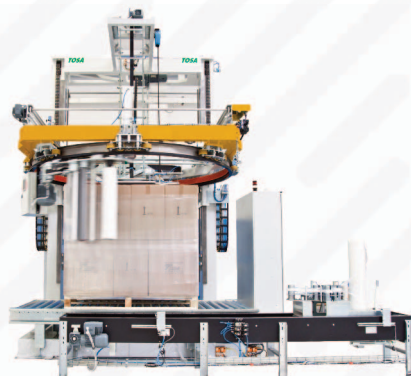



Raise your Expectations

Affordable X-ray Inspection Solutions without Compromise

Intelligent detection, ease of use and machine reliability are key components of effective product inspection.

If producing safe, compliant and high quality products is critical to your business, then look no further than the X34 x-ray inspection system for outstanding contamination detection.

Find out why X34 is winning orders all over the world.



Watch our product video

► www.mt.com/uk-X34

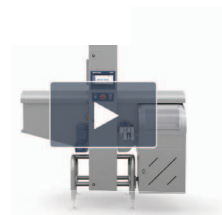

Mettler-Toledo Ltd
Tel: 0116 234 5095
Email: enquire.mtuk@mt.com

METTLER TOLEDO

Feature: Sustainability

Making a material difference

Machinery manufacturers are developing equipment to handle new, or less of the same materials to meet sustainable goals

In the search for more sustainable solutions, machinery supplier Multivac and materials company DS Smith have teamed up to design and produce ECO Bowl – a new solution for fresh foods in modified atmosphere packaging (MAP) based on corrugated cardboard. The two companies have formed a strategic partnership to ensure maximum scalability of the ECO Bowl solution to customers in food production and retail industries across Europe.

The new pack is a fully recyclable corrugated cardboard tray covered with a plastic skin film and a lid film that reduces plastic by up to 85% versus a traditional tray. And ECO Bowl's plastic skin and lid film can be easily removed for disposal, leaving the corrugated tray for recycling.

This new option is designed to run on Multivac thermoforming packaging machines and tray sealers and can guarantee equal shelf life when compared with MAP packs for fresh food, or even improve it, says Multivac



This option saves on plastics

Moving sectors, and with its Innopack Kisters tray packers, KHS is now enabling cans of food and beverages to be wrapped in paper. The new technology provides an alternative to shrink film or wrap-around cartons. "Our customers now want alternatives to the usual packaging systems such as film which should be as eco-friendly as possible," says Karl-Heinz Klumpe, packaging product manager at KHS. To this end, the paper wrapping has now been developed together with

an international beverage producer and works on packs of 12 or 24 cans at up to 90,000 cans per hour. KHS has also just developed a returnable PET bottle with Alpla.

Heat-sealable paper pouches are now being offered by Volpak on its equipment, a pack format that is suitable for a range of foods including confectionery. These pouches can be etched or flexo printed to stand out on shelf. The company's machines, which are available in the UK from Engelmann & Buckham (E&B), can also produce



E&B are now offering paper pouch makers

flexible pouches made of coated and uncoated kraft papers.

Meanwhile, Holmach's new partner, Atlantic Engineering of Belgium has developed and patented a solution that aims to cut plastics use, reduce transport costs, waste and improve food quality all in one compact solution. Billed as reducing plastics usage by 90% when compared with 3, 5 and 10 litre buckets, Innofill by Atlantic is a large pre-formed pouch filler that can be connected directly to a cooking vessel.

RECYCLABLE STRIP PACKAGING

Outside food, Romaco says that several international pharmaceutical companies are currently testing its Push Packs, its recyclable strip packaging for pharmaceutical solids that it developed with materials supplier Huhtamaki. The structure of the strip packaging foil enables it to be recycled back into the material loop, according to the UK agents Pharma Machinery.

In operation, Huhtamaki's foil is processed into four-side sealed strips with a push-through function using Romaco Siebler's heat-sealing technology. The Push Pack foil has the same barrier properties as blister foil but is much thinner and lighter. And as well as offering materials savings, the packs



The new Push Pack is now a recyclable option



Paper wraps for drinks cans

can be up to 60% cheaper than Al/Al blisters.

Back to foodstuffs, and Optima has developed a recyclable coffee capsule system that features a single-material capsule with recyclable lid film and a compatible packaging system. Working with partners to devise

the 'Green Lution' system, it includes Optima's CFL machine that combines filling accuracy for a variety of coffee types in minimal space, with optimal film utilisation, lower energy and gas consumption and a minimum production reject rate of below 0.05%.

Audion says it gets asked a lot about the materials that it offers to be processed

on the machinery it manufactures which is why it is now supplying and using 100% recycled plastics for its equipment.

The company is highlighting this fact on the bags its equipment makes so that when a product is packed, the end customer is left in no doubt.



The Speedpack Hybrid is manufactured by Audion

The Speedpack Hybrid is a packaging machine that utilises both rollbag and bags on a roll which gives customers the option of making a recycled bag at whatever length required which minimises material waste as the bag can be made to suit the product.

POST CONSUMER WASTE

Yorkshire Packaging Systems (YPS) has just expanded its shrink film range with the addition of recycled-content polythene films to help businesses across the UK meet their circular economy goals, as well as future-proofing their wrapping operations by achieving Plastic Tax exemptions.

Responding to increasing customer demand over the last six months, YPS's decision to supply post-consumer waste films is designed to offer relief for users with environmentally-friendly packaging aims as well as cost considerations. These films, which are designed for transit wrapping applications, are manufactured in the UK at a BRC-certified site using post-consumer waste collected exclusively from UK waste streams.

They are available in a range of widths, thicknesses, single-wound or centrefolded and in 30%, 50% and 70% recycled content specifications.

To complement these films, YPS can also supply a range of shrink wrapping systems that are compatible, including sleeve wrappers, high-speed side sealers and e-Commerce bagging lines.

- www.audionelektro.co.uk
- www.buckham.co.uk
- www.holmach.co.uk
- www.khs.com
- www.multivac.co.uk
- www.optima-packaging.com
- www.pharmamachinery.co.uk
- www.yps.co.uk

UV Disinfection of Air and Surfaces

- Ducts • Pass throughs
- Stores • Conveyors

01256 892 194

jenact@jenton.co.uk



JenAct by



Jenton International

Feature: Sustainability

Pack design concept is an award winner

For its latest eco-friendly packaging design concept called AYA, Sidel has won a prestigious World Food Innovation Award (WFIA) in the 'Best Drink Packaging Design' category. With the prizewinning AYA design, Sidel has developed an end-to-end packaging alternative for still water, covering everything from 100% recycled PET (rPET) primary to carton secondary and on to tertiary packaging alternatives – all optimised for local distribution methods. Sidel says the result is an overall cost-effective and sustainable packaging concept which is tailor-made to match circular economy requirements, while improving environmental impact and industrial production efficiency.

"To us this award means great recognition from the judging panel on how AYA meets sustainability requirements," says Laurent Lepoitevin, packaging design engineer at Sidel. "We are honoured that with this distinction, the WFIA appreciates how much our AYA concept contributes in terms of designing and valuing a sustainable packaging solution as a whole."

T 01707 292820
W www.sidel.com



Sidel's eco-design meets primary, secondary and tertiary pack needs



Sealed Air's Packforum event discussed the power of vacuum food packaging, as seen here with meat

Managing a retail format

Tesco shared its sustainability aims at the Sealed Air Packforum event, some of which are highlighted here

"As we go through this year, simplicity of packaging is key," Denise Mathieson, senior UK technical packaging manager – fresh and packed quality at retail giant Tesco told Sealed Air's Packforum. "How can we simplify packaging structures without adversely affecting shelf life?" she asked. And, she felt that when material is presented for recycling, getting it back through the system as a new piece of packaging has to be everybody's ultimate ambition.

"We need to manage the balance between pack performance and consumer appeal," she said. Acknowledging, however, that COVID-19 had impacted

consumer behaviour as before the pandemic, reducing plastic packaging was in the top three of consumer ambitions, while mid-crisis, this had dropped down to number 15. She felt this wasn't a permanent change and so the retailer continues with its work in this area in the meantime.

however what that looks like in six months, a year or two years from now, who knows?"

One thing Mathieson is particularly proud of is Tesco's preferred materials guidelines which she describes as a massive task to implement and also maintain.

"We're in continual dialogue with our suppliers, different packaging companies, brand owners and more importantly industry bodies to explain the decisions we've made," she said.

This Red, Amber, Green list has helped to remove hundreds of tons of non-recyclable material, and "we've been brave and spoken the truth from the heart," she says.

But she is keen to stress that Tesco's approach is not to demonise plastic, even though



Areas that have been affected, of course, are in fresh meats as well as fruit and vegetables where the desire for hygienically packaged products has been preferred. "We know that at this time, loose (meats) is not in favour,



the retailer's stated aim is a billion pieces of plastic removal by the end of 2020. "We know that it's a useful material due to the protection it provides to food and we absolutely don't want to make any packaging changes that can (negatively) impact food waste. "However, where plastic isn't playing a useful part, we have to ask ourselves – do we really need this packaging?"

She also felt that the work on harmonising labelling systems was going to be a key to success in embracing the circular economy going forward and welcomes the latest update from OPR (on-pack recycling label) in moving towards a binary system for labelling. "Now, for the first time, we can really start to remove the confusion from customers," she says. "We see OPR as a really positive initiative which is why we place their logos on all our packaging."



Duncan McIntyre from Sealed Air

She felt that although COVID-19 may have affected the green agenda just now, the retailer still ensures it is using the optimum amount of packaging and where possible, the recycled content increases year on year. "Ultimately, if it is determined that multi-layered materials are needed, we're comfortable having this in our packaging portfolio," she said. "However, I will ask the entire packaging industry to work with us and recyclers to find

a positive recycling solution."

• Denise Mathieson was interviewed by Duncan McIntyre, fresh red meat marketing director, EMEA

at Sealed Air as part of its on-line Packforum event that was designed to address some of the most critical challenges facing the food industry by

improving sustainability, enhancing food safety and optimising efficiencies.

T 01480 224000

W www.sealedair.co.uk



Taste the future with flexible automation

Getting new foods into production quickly and efficiently is key to satisfying today's demanding consumers. Getting your products to market quickly needs production lines that can handle unforeseen needs and unusual shapes and sizes.

Fast, flexible and accurate, our robotic solutions can improve the performance and speed of even the most demanding picking processes. Discover more here:

<http://bit.ly/ABBRobotPicking>



Feature: Sustainability

Robots are remade to bring benefit

ABB is making manufacturing more sustainable by recycling and remanufacturing thousands of old robots across the world. The company is remanufacturing robots, controllers and manipulators, refurbishing them to give them a second life. This can help customers unlock new functionalities and advanced services while reducing maintenance costs and maximising return on investment, while sourcing unused and discontinued robots for this purpose ensures older robots avoid being scrapped when their lifetime could be extended.

Remanufacturing enables existing robot users to sell inactive or legacy robots to ABB with an attractive buy back service, rather than scrapping them or leaving them unused in a corner of the factory. Over the last 25 years, thousands of robots have been refurbished and upgraded by ABB's remanufactured robot teams, to give them a second life. As well as previously owned robots, peripheral equipment such as controllers and manipulators are refurbished to 'like-new' conditions at one of ABB's Global Remanufacture & Workshop Repair Centres.

Before being labelled as an ABB-certified remanufactured robot, every second-hand unit undergoes rigorous checks, including a detailed inspection and a minimum 16-hour functioning test. Each remanufactured robot comes with a two-year warranty and buyers of refurbished equipment enjoy the same level of support from local service teams, including installation and training, as they would with the purchase of a brand new ABB robot.

T 01908 350300
W www.abb.com



Old robots are remanufactured to be 'as new'



Solar panels and smart monitoring of all power usage is planned for SMC's Milton Keynes site

Simple change brings eco-gain

SMC achieved a range of environmental gains in 2019, with this year's objectives underway...

Pneumatics and automation company SMC is proud of its environmental track record with many ground-breaking initiatives already in place at its Milton Keynes facility.

But as an ISO 14001 certified manufacturing company, SMC UK is constantly looking at ways to reduce its impact on the environment and has two environmental objectives for 2020:

- to reduce plastic packaging purchases by 30% from 2019 levels
- to reduce carbon footprint by 10% each year in line with productivity.

During 2019, SMC achieved a 50% reduction in the amount of plastic packaging by just switching to crimped paper to void fill goods shipped from the UK warehouse last year. Now, it has launched two new projects that will help it achieve this year's target.

In the packaging department, for instance, it has introduced a bubble wrap re-use scheme. Bubble wrap collection stations are now sited around the 24,000sq m factory and warehouse facility where anyone can leave good quality used bubble wrap. This will then be re-used to package products sent to customers, saving on future bubble wrap purchases and recycling costs.

At the same time, a plastic bag re-use scheme has also been introduced, which has been facilitated by part numbers now being written on dockets placed inside the bags themselves, rather than written on the bags which meant they could only be used for that single transfer. Now, these bags can be used several times.

"These two simple changes are already making a real difference with plastic packaging purchases dropping by 40% in the first three months of the year,"

explains SMC's environmental officer Anna James.

SMC's second objective is to reduce its carbon footprint by 10% each year, in line with productivity. Reductions have already been achieved through the use of more energy efficient

production machinery, moving from mostly diesel to petrol and hybrid company vehicles and the installation of energy efficient LED lights. In 2020, even more

LED lights and sensors will be installed in addition to about 1,200 lights they have already replaced.

Other energy efficiency projects planned for 2020 include the installation of solar panels at the site and smart monitoring of all power usage through sub meter stations.

T 01908 563888
W www.smc.uk



Anna James is SMC's environmental officer

THE INTELLIGENT SOLUTION FOR YOUR VACUUM PROCESS

The new R5 PLUS

BE CONNECTED.
BE PLUS.

- CONTROL AND MONITORING
- COST SAVINGS
- PROVEN ROTARY VANE VACUUM TECHNOLOGY

Busch (UK) Ltd.
+44 (0)1952 67 74 32 | sales@busch.co.uk | www.buschvacuum.com

**U
BUSCH**
VACUUM SOLUTIONS

Flexible packaging machinery not up to speed?

pfm[®]
packaging machinery
united kingdom

Let PFM boost your production



Machinery

- Horizontal flowrappers
- Vertical form fill seal bag makers
- Horizontal form fill seal pouch machinery
- Multihead weighers

Bag Styles

- Pillow packs
- Stand up bags
- Pouches
- Recloseable packs
- MAP

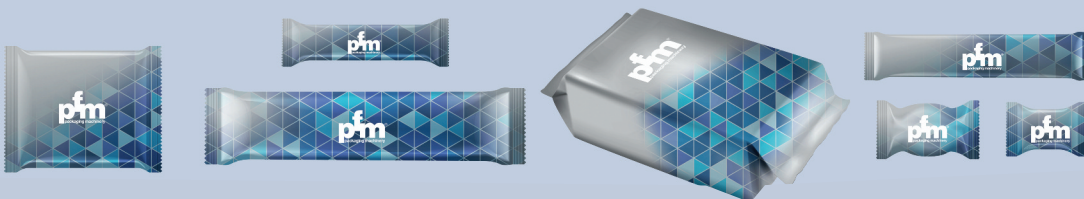

PFM Packaging Machinery Ltd, PFM House, 2 Pilgrim Way, Stanningley, LEEDS LS28 6LU
T: +44 (0)113 239 3401 E: sales@pfmuk.com W: www.pfmuk.com

Labelling, Coding and Marking

Inkjet printers are delivering cost savings for a busy contract packer

Martek Industries has installed three United Barcode Systems LCX high-resolution inkjet printers at contract aerosol filler Aztec Aerosols to improve the efficiency and reduce costs on its outer case packaging lines.

Having seen the UBS systems printing directly onto white and brown kraft outer case cartons at the PPMA Show, the units were identified as a potential solution to hand-applying labels by Aztec Aerosols. Following a successful trial, the UBS LCX system was chosen since it delivers all the information previously printed onto labels to be clearly and legibly printed directly onto cartons including consistently readable barcodes.

As a contract filler, Aztec also required the system to be capable of storing large quantities of print layouts which could then be easily selected for printing. Despite its compact design, the LCX system features an integrated 5.7 inch touch screen controller which is

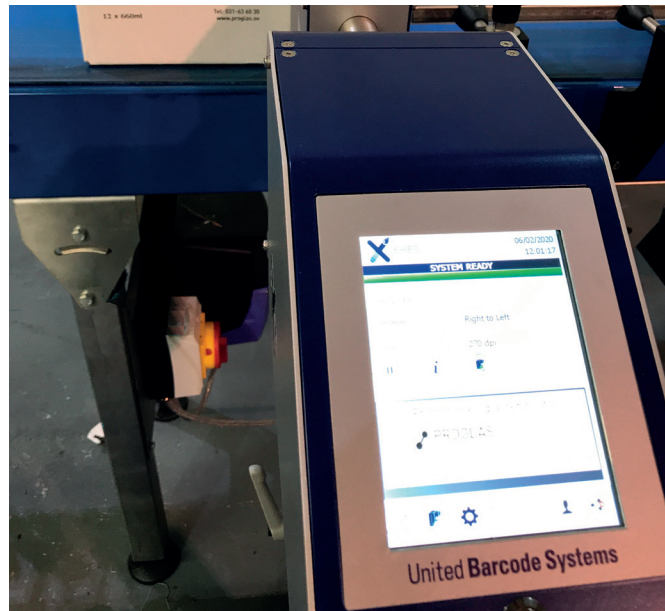

Cost savings resulting from the installation have been in the region of 80%

ideally suited to previewing print layouts and monitoring the printing.

Three systems have been installed to print onto cartons immediately after taping, each of which has a driven belt conveyor to ensure smooth transfer past the printhead

for optimum print quality. The LCX system uses a 72mm-high Seiko print engine with print resolution up to 180 x 360dpi and can print text in any font and point size from 2 to 72 mm high, detailed graphics, barcodes and also 2D codes.

The system met Aztec's objective of improving efficiency by eliminating the offline label printing process and the time-consuming hand-application of labels. Costs have been significantly reduced with a 1 litre bottle of UBS ink printing over 200,000 cases at a cost of about 80% less of the equivalent labels and ribbons.

A further benefit has been the elimination of backing paper waste from labels which cannot be recycled with the company's other paper waste due to the siliconised surface.

Aztec's managing director, Paul Butcher has been very impressed with the systems. "The printers have proved very reliable and have streamlined our end of line process," he says. "The cost savings have also proved to be considerable and with the capacity to fill over 2 million cans a month, we are confident the printers will contribute significantly to improving efficiency."

T 01543 502202

W www.martekindustries.co.uk

Live Factory Acceptance Tests for a range of self-adhesive labellers are now available

COVID-19 has put a stop to face to face Factory Acceptance Tests (FATs), even though they play a critical part in the labelling machinery purchasing process, which is why Herma has adapted its existing FAT procedures at its manufacturing facilities based in Suffolk.

The latest virtual



The labelling machines are manufactured in Suffolk

FAT has received positive feedback from one blue chip customer who thanked the Herma team for "the best one so far".

Herma manufactures its equipment in the UK which has proved to be beneficial to local customers requiring units urgently during this challenging time.

T 01440 763366

W www.herma-labellingmachines.co.uk

White Paper shows drinks code benefit

Markem-Imaje has released a White Paper that consolidates everything beverage manufacturers need to know to drive product, case and pallet coding efficiencies and minimise waste while protecting and promoting their brands.

W www.markem-imaje.com/beverage-coding-white-paper



Latest fibre lasers offer beverage makers a fast and efficient option

Macsa ID has launched a range of next generation fibre lasers specially designed to offer low cost of ownership and maximum marking resolution and definition for high speed beverage can production lines. The company's SPA F-100 can code up to 172,000 cans per hour.

The company says the new equipment provides a more precise alternative to continuous inkjet printing for the beverage industry as the laser generates a reaction in the aluminium cans to produce excellent visibility as well as ensuring a reliable and sustainable coding method without the use of inks.

NEW FIBRE LASER CODERS OFFER SPEEDS OF UP TO

172,000

cans per hour, with guaranteed legibility, traceability and also security, even in humid settings

In addition, the option of integrating these lasers into a station or enclosure produced from food-grade stainless steel with water ingress protection, can also be supplied. An option to add a code verification system that is scalable to suit individual requirements, is also available.

These SPA F-100 models feature a dual core signal processor that performs real time management to accelerate data input and increase laser marking speeds with increased resolution simultaneously. The flat field lenses are designed to provide higher quality accuracy and output over the entire work area. They are reliable in even the harshest conditions.

T 01462 816091

W www.macsa.co.uk



Proven to be the most advanced print & apply systems

- Print & Apply outer-case barcode labelling
- Pallet labelling
- Self-adhesive labels & thermal ribbons
- Lowest cost of ownership

Tel: 0161 655 4846

Email: sales@ilsystems.co.uk

Visit our website: www.ilsystems.co.uk

Industrial Labelling Systems Ltd,
Units D4 & D5 Brookside Business Park, Greengate,
Middleton, Manchester, M24 1GS

Why go anywhere else?

Contact Industrial Labelling Systems for a complete labelling solution



Components



Pneumatic fastening clamps are designed for faster production

Elesa has launched a powerful new MM range of pneumatic clamps (up to 475Nm) which offer fast repetitive clamping cycles on manual or automated production lines to help deliver lower costs and more efficient output for users.

The MM range is available as side locking, axial locking and axial centre locking (twin jaw) designs to suit the many variations required for handling jigs and components in all orientations. They are produced in robust black oxide finished steel housings readily fitted to production machines of all types using an extensive selection of accessories.

These provide many clamping adaptations quickly and easily with stock components to minimise down time. Meanwhile, correct positioning at speed can be controlled with Elesa MM proximity switches connected to the clamping controller.

T 01526 322670

W www.elesa.com

The software for image processing is improved

The parameterisable standard software for two and three-dimensional image processing, called uniVision, has been given an update. The latest release 2.2 enables smart cameras and control units to be integrated into controls quickly and easily via a PROFINET interface for the first time. New software modules and new functions for the visualisation of results also make this update particularly valuable for users, says wenglor.

Thanks to the integrated interface in smart cameras and control units, the results of image and profile evaluations can now be transferred in real time via the PROFINET Industrial Ethernet standard. This makes seamless communication between the sensor, software and control even easier.

“With about 6.4 million recorded devices, it is the most used real-time interface in the world,” explains wenglor product manager Martin Knittel. “This is therefore



uniVision 2.2 includes useful new functions for the image processing software

an ideal opportunity for us to shape this development by integrating PROFINET in uniVision,” he says.

Another feature of the uniVision update 2.2 is the new web-based visualisation function. This enables the results to be displayed as overlays (for example, measurement points or lines) directly in the image or height profile. A ‘good/bad’ display of the overlays in the signal colours red and green is also available, showing the user whether the test points are

OK or not. All measurement results can thus be shown quickly and flexibly via a browser-based display.

“The user wants to see at first glance what the cameras or 2D/3D profile sensors are seeing – along with the results of the evaluation easily and directly in the image or profile,” says Knittel. “All relevant information visualised clearly on a screen makes the system tangibly more user-friendly for end users.”

T 01536 313580

W www.wenglor.com/uniVision

Digital whisky cask filling process project could save millions for Scotland’s industry

Researchers at the University of Strathclyde’s Advanced Forming Research Centre (AFRC) have collaborated with industrial partners including Siemens to devise a digital whisky cask filling process that could save Scotland’s £5.5 billion whisky industry millions of pounds each year in inventory costs.

Bringing advances in Industry 4.0 to a manufacturing process that is steeped in tradition, project partners include the AFRC, Siemens,

Diageo and Kigtek. The work is set to save distillers significant capital expenditure from logistics and warehouse space for additional casks by tackling the problem of inconsistent cask filling levels resulting from overspill and under fill.

The project has proved a real collaboration

“The collaborative nature of the project combined the centre’s design and digital manufacturing expertise with industry partner Siemens’ instrumentation know-how,” says Dann McMahon of AFRC. Siemens also provided software, hardware, design work and digital twin know-how to the project and further support with the cloud analytics using its cloud-based open IoT operating system.

T 0845 850 7600

W www.siemens.co.uk



Minimising power losses at high speed

New drive controllers and motor filters for high frequency applications from KEB Automation are helping customers develop efficient machine concepts for turbo blowers and CNC machine tool spindles.

T 01933 402220

W www.keb-uk.co.uk

Data acquisition tools

ifm electronic has launched an easy-to-use plug-and-play data acquisition solution that allows IO-Link sensors to send process values to the cloud even from locations where no network connection is available.

The new IO Key supports up to two IO-Link sensors and transmits data via the GSM mobile network. It is fully preconfigured and requires no SIM card.

Users can visualise and analyse the data acquired by the system with a web-based dashboard that also offers options for setting limit values. If these values are exceeded, warnings can be sent automatically to the plant operator either by email or by text message. Additionally, all data from the sensors can be summarised



ifm's IO Key supports up to two IO-Link sensors and requires no SIM card

and reported as required.

Ideally suited for monitoring and evaluating the operation of remote sections of a plant, such as tank farms or compressed air storage vessels, ifm's new IO Key needs only a 24 V DC power supply and access to the GSM network. No connections to

a controller, PC or the company network are required.

To suit the widest range of user requirements, it is offered in versions that transmit data to the cloud once per day, once per hour, once per minute and once every ten seconds.

T 020 8213 0000

W www.ifm.com/uk

New track system allows for higher driving forces

HepcoMotion has introduced the DTS+ track system, the latest addition to its range.

The DTS+ incorporates key features of Hepco's PRT track system and original DTS, combining them with a high load capacity connection from the carriages to the drive belt. The carriages will not disengage from the belt, allowing transmission of higher driving forces compared to the original.

While the original DTS will often be the right choice for many applications, the DTS+ is suitable for applications with high loads, a vertical orientation, or where the free space inside the track circuit is required to integrate additional equipment units.

T 01884 243400

W www.hepcotion.com



A range of Washdown Gearmotors and Inverters designed specifically for use in extreme conditions found in the food and beverage industry.

- Smooth bodied hygienic design
- Stainless steel shaft and fixings
- Easy to clean
- Protection up to IP67K



nsd tuph for the food industry

Complies with FDA Title 21 CFR 175.300

Tested with a wide range of cleaning agents - ask for our approved list



Components

New I/O modules simplify connections in harsh areas

Industrial producers can more easily and efficiently connect to devices in hazardous areas using the new Allen-Bradley 1718 Ex I/O modules from Rockwell Automation. The intrinsically safe distributed I/O modules provide EtherNet/IP connectivity to field devices in Zone 0 and Zone 1 hazardous areas.

The 1718 Ex I/O modules can reduce wiring in industrial applications because they

can be mounted in Zone 1, closer to field devices in these hazardous areas.

The I/O modules can also save space with a compact, chassis-based I/O design that contains the primary power supply and an optional redundant power supply in the chassis.

Different chassis options and slot sizes allow users to scale the 1718 Ex I/O modules to meet a wide range of system requirements. Add-on Profiles

in the Studio 5000 Logix Designer application help ease configuration of the modules. And a dual-port EtherNet/IP adapter that enables a Device Level Ring (DLR) topology can help improve network resilience.

The 1718 Ex I/O modules are designed for hazardous applications found in industries such as chemical, food and beverage. An ATEX-certified enclosure is required for the 1718 Ex I/O modules to be mounted in an ATEX Zone 1 area.

As a complete solution, Rockwell Automation collaborates with its Encompass partner Pepperl+Fuchs, who offer Zone 1 certified enclosures.

The Allen-Bradley intrinsically safe distributed I/O portfolio also includes the 1719 Ex I/O product family, which is certified for mounting in Class I, Division 2 (North America) and Zone 2 (global) hazardous areas.

T 0870 242 5004

W www.rockwellautomation.co.uk



Rockwell Automation has launched the Allen-Bradley 1718 Ex I/O modules

IXrouter inclusion in the EPLAN Data Portal is easy option

The component data of all IXON routers and accessories is now included in the EPLAN Data Portal. This makes it very easy for users of the EPLAN Platform to consult data from IXON routers and accessories and include those in their designs.

Remote service and IIoT service provider IXON is advancing worldwide to offer machine builders and system integrators remote access and data services for industrial machines and building management systems. To provide these services, IXON uses IXrouters, self-designed VPN gateways optimised specifically for this application.

By adding IXON's IXrouters to the EPLAN Data Portal, it becomes much easier and more accessible for designers of industrial installations to combine IXON with other products in their EPLAN designs.

"Many of our customers use EPLAN for the design of switch cabinets and so adding all IXON products to the EPLAN Data Portal was therefore a natural choice," explains Bart van den Corput, product manager at IXON.

T 00 31 857 441 105

W www.ixon.cloud

We have the solution.

Position. Transport. Rotate.

Orientalmotor

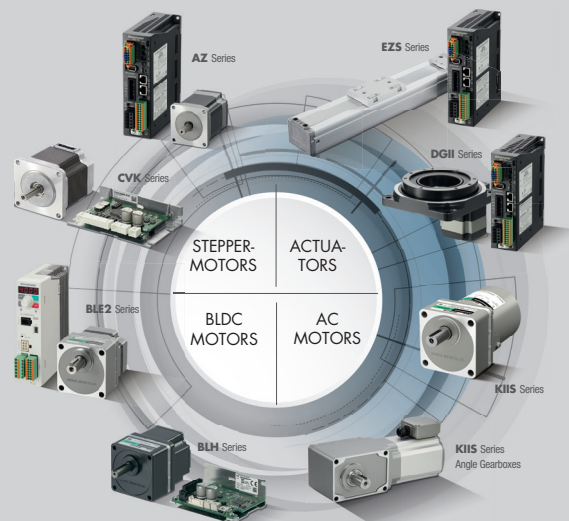

“Sensors are the most important components of smart machines.”

Dr. Alexander Ohl
Director of Development,
wenglor sensoric

Ready for Industrie 4.0

PNG//smart Sensors - Unique Communication and Performance

- Highly flexible production up to lot 1
- Increase in productivity and efficiency with condition monitoring
- Maximum precision with targeted optics and calibrated switching point

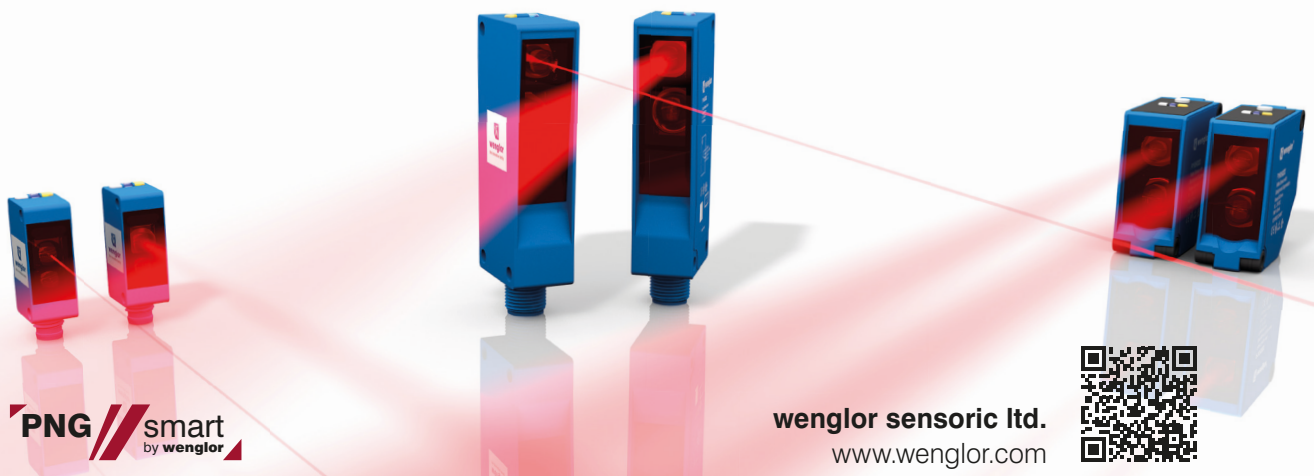

Regulations

Running to keep still with IoT device security

Joe Lomako

BUSINESS DEVELOPMENT MANAGER (IoT) AT TÜV SÜD



Although current cyber security standards are lacking on some detail and appropriate applications, they are at least a good first start to keep early IoT business adopters safe...

Industry 4.0, the fourth industrial revolution, is pushing industry towards a more automated, and sophisticated manufacturing process and consequently, the systems we use are becoming increasingly complex, as a plethora of new technologies are employed by today's manufacturers.

The process involves various components such as cyber-physical systems, cloud computing, edge computing, Artificial Intelligence (AI), the Internet of Things (IoT) or the Industrial Internet of Things (IIoT), to name but a few. But usually there is some physical component or sensor (usually many hundreds or thousands) which will be part of the system, often referred to generically as an IoT device. These components and sensors connect industrial systems to each other and are the interface to the outside world – and they are continuously collecting data.

Although these components and sensors could be regarded as the strength of any given system, it is entirely possible that it could conversely also be its Achilles heel. According to a report from Kaspersky Lab earlier this year, half of all industrial control system networks have faced some form of cyberattack. Some connected devices lack the appropriate cyber robustness to prevent attacks and this, coupled with the fact that some control systems could be using outdated or bespoke

operating systems, increases cyberattack vulnerability.

When we visit sites, we are finding that there is sometimes a perception that because a system is complex that it is automatically secure. That is unfortunately not always the case.

The introduction of the NIS Directive (security of network & information systems) in Europe is intended to improve this situation, but uptake is slow, as is the introduction of the standards required to assist in improving total cyber security. However, standards do exist or are being developed by international organisations aimed at

products. More importantly is that this standard has been mandated in California under State Bill No. 327, and it will likely pervade across the US.

CONSUMER DEVICES

However, the scope of the Draft EN 303 645 standard is aimed only at consumer IoT devices, so is not applicable for industrial products, although the general principles therein can certainly be applied generically to afford some modicum of protection.

There is some debate that the present cyber security standards are lacking some detail and appropriateness in application, and do not

probably be more familiar to operators and integrators of control and automation systems. While this standards series has a mix of process and technical requirements, it covers what we would typically call a 'product'. Therefore, and in addition to this, process requirements can be found in IEC 62443-4-1, and technical requirements in IEC 62443-4-2.

Although it may seem that the standards do not cover everything, and they don't; they do at least offer that first line of defence. However, there are other options outside the present standards landscape, and that is to perform more stringent, bespoke testing or 'pen testing'. This will identify deeper and more serious threats to a machine and the IoT system within which it sits. What is more, threat resilience is an iterative task. Not all threats may have been discovered on the first assessment as they may not even exist yet.

Sadly, at the present moment in time there needs to be more traction in device and component cyber assessment and it would be prudent for machinery end users to ask their supplier about the level of cyber assessment that has been performed and to also prove its cyberattack resilience.

It would be prudent for end users of machinery to ask their suppliers about overall cyberattack resilience

providing baseline protection, which would help to deliver basic security provisions for a first line in cyber defence. For example, this would include not having default passwords or ensuring that a device's software can be updated 'over the air'.

The two main standards that we see for IoT devices are NIST 8259 (US) and Draft EN 303 645 (EU). The scope of the NIST has been written with the intent to address a wide range of IoT type products, which have at least one transducer. So, it follows that it can apply to 4.0 industrial

adequately cover the scope of typical industrial applications. That may be true, but they are at least a good first start where nothing previously existed with this detailed scope.

There are several groups of published standards which are aimed at improving security from network infrastructure to devices. For example, it is possible that an IoT device could be certified under the IEC 62443 series of standards, which aims to mitigate risk for industrial communication networks by providing a structured approach to cyber security. This would

I For more information contact www.tuv-sud.co.uk
TÜV SÜD is the PPMA Group's technical and legislative partner



your carton packaging solution!



www.et-pack.com ENG 04/2014 42883330004



End Load



Ecowrap®



Top Load



Case Packing



Robotics



Infeed



Conveyors



Engineering



ETPACK SPRINTER UK
Suite 16, Unit 4B, Kingfisher Court Business Centre,
Hambridge Road, Newbury, Berkshire RG14 5SJ
+44 (0) 1635 905 090
dianne@et-pack.com

www.et-pack.com

Who What Where

Who's done what and gone where...

MTC



Mike Wilson has joined the Manufacturing Technology Centre (MTC) as

chief automation officer and will lead the organisation's drive to increase the adoption of automation throughout UK manufacturing. He brings nearly 40 years of experience in delivering automation to a wide range of industry sectors, working for both users and suppliers of automation and also as an independent consultant. Wilson is also the current chairman of BARA, the British Automation and Robot Association.

Shemesh Automation



Tony Bryant has joined Shemesh Automation as sales director

in response to increased demand for its equipment in the UK. He brings over 27 years of experience in capital machinery sales to the new role, joining from Ilapak where he was technical sales manager. Previously he headed up the EMEA region for Peco-InspX and the UK territory for Loma Systems.

CWM Automation



Nick Birkin has joined CWM Automation as sales

director where he will be responsible for sales team leadership as well as developing sales strategies for the company. He will also oversee the implementation and management of the sales activities and identify new market opportunities. Birkin was previously director of sales at BW Integrated Systems, developing sales in EMEA.

Domino



Alberto Sanson is the new chief information officer at Domino

Printing Sciences following the retirement of **Dick Wallin** who led Domino's IT team for the last twenty years. Sanson joins from Illinois Tool Works where he was group IT director and in his new role, he will be part of the executive leadership team responsible for the IT function.

CKF Systems



Dorothy Howell, sales and quality co-ordinator at CKF Systems

for over 18 years, retired in the summer when all of CKF gathered into the workshop to say thank you for her valued service. She was also presented with a card and leaving present by md **Bryan Wheeler** and her line manager **Robbie Dawson**.

Schubert Business Development



New company Schubert Business Development is headed by shareholding partners **Ralf** and **Gerald Schubert** as well as **Peter Gabriel**, the trio that manage Gerhard Schubert GmbH, producer of modular packaging machines. This independent company aims to identify market trends and opportunities while promoting innovation for various industries. Partnerships and equity investments with companies in the packaging sector will also be pursued going forward.

Romaco Innojet



Michael Van den Bossche is the new managing director of

Romaco Innojet where he will be responsible for sales, laboratory, customer service and product management. He will share the management of the company with **Bastian Käding** who has been at the helm since 2018, with responsibilities for project management, engineering, operations and administration.

Interroll



Maurizio Catino is taking over the role of executive vice president global

sales & service and member of the group management team from **Christoph Reinkemeier**, who is leaving the company. Catino joined Interroll in 2013 and this promotion follows several roles held in this time.

Bob Hinchcliffe



Bob Hinchcliffe, managing director of James

Mae Industries, has successfully completed his 92 day challenge to raise money for the NHS Charities Together fund by walking around his garden with his trusty Bergen backpack. During this time, he has carried a total weight of 2.31 tons, walked a total of 205,623 steps and climbed the equivalent of 504 flights of stairs. <https://www.gofundme.com/f/captain-bob-respectfully-doing-a-039captain-tom039>.

TÜV SÜD



Mary Grigsby has been promoted to head of the UK

Product Service division of TÜV SÜD having held various technical and managerial roles since joining the company 31 years ago as a graduate in its EMC Service Line. Most recently, she has been director of test operations, having worked across product sectors including aerospace, consumer, electronics, medical and automotive.

Uhlmann Group



Norbert Gruber, chairman of the executive board at the

Uhlmann Group, sadly died in the summer following a long illness. Since his appointment in February 2011, he has contributed significantly to the growth and success of the company. "We are saddened by this loss," said **Tobias Uhlmann**, chairman of the supervisory board of the Uhlmann Group.

MACHINERY FINDER

Ancillary Equipment

To advertise contact Robert Beswick

T 020 8773 5527 E robert.beswick@ppma.co.uk

AFTERMARKET SPARES & SERVICING

Stellar Technik MACHINE KNIVES, PUNCHES & STS CUTTERS
 T: 01460 270600 E: enquiries@stellartechnik.com
 www.stellartechnik.com

AS-I

ifm electronic Ltd
 Oldfield Road, Hampton, Middlesex TW12 2HD
 T: 020 8213-2222 E: enquiry.gb@ifm.com
 www.ifm.com/uk

CABLES / POWER SUPPLIES

ifm electronic Ltd
 Oldfield Road, Hampton, Middlesex TW12 2HD
 T: 020 8213-2222 E: enquiry.gb@ifm.com
 www.ifm.com/uk

CARBON REDUCTION

Power Capacitors Birmingham, B11 2BH
 T: 07780 470457
 E: miked@powercapacitors.co.uk
 www.powercapacitors.co.uk

CLEANING & HYGIENE

Jeros UK Ltd
 E: info@jeros.uk.com
 T: 0843 2892881
 www.jeros.uk.com

COLOUR SENSORS

ifm electronic Ltd
 Oldfield Road, Hampton, Middlesex TW12 2HD
 T: 020 8213-2222 E: enquiry.gb@ifm.com
 www.ifm.com/uk

SICK (UK) LTD
 Waldkirch House, 39 Hedley Rd, St Albans, Herts AL1 5BN
 T: 01727 831121 F: 01727 856767
 E: info@sick.co.uk www.sick.co.uk

CONDITION MONITORING

ifm electronic Ltd
 Oldfield Road, Hampton, Middlesex TW12 2HD
 T: 020 8213-2222 E: enquiry.gb@ifm.com
 www.ifm.com/uk

CONDUCTIVITY SENSORS

ifm electronic Ltd
 Oldfield Road, Hampton, Middlesex TW12 2HD
 T: 020 8213-2222 E: enquiry.gb@ifm.com
 www.ifm.com/uk

CONTROL PANELS

PILZ Automation Technology
 Pilz House, Little Colliers Field, Corby, Northants, NN18 8TJ
 T: 01536 460766 E: sales@pilz.co.uk www.pilz.co.uk

CONTROL SOFTWARE

ifm electronic Ltd
 Oldfield Road, Hampton, Middlesex TW12 2HD
 T: 020 8213-2222 E: enquiry.gb@ifm.com
 www.ifm.com/uk

PILZ Automation Technology
 Pilz House, Little Colliers Field, Corby, Northants, NN18 8TJ
 T: 01536 460766 E: sales@pilz.co.uk www.pilz.co.uk

CONVEYORS - BELT

CKF T: 01452 728753
 E: info@ckf.co.uk
 THE AUTOMATIC SOLUTION www.ckf.co.uk

CSL T: 01283 552255
 E: sales@conveyorsystemsLtd.co.uk
 www.conveyorsystemsLtd.co.uk
 CONVEYOR & WAREHOUSE SOLUTIONS

CONVEYORS - MOTORISED DRUMS

Interroll Ltd
 Orion Way, Kettering, Northants, NN15 6NL
 General Enquiries: gb.sales@interroll.com
 Service Enquiries: uk.service@interroll.com
 T: 01536 312770 www.interroll.co.uk

CONVEYORS - ROLLER

CKF T: 01452 728753
 E: info@ckf.co.uk
 THE AUTOMATIC SOLUTION www.ckf.co.uk

CSL T: 01283 552255
 E: sales@conveyorsystemsLtd.co.uk
 www.conveyorsystemsLtd.co.uk
 CONVEYOR & WAREHOUSE SOLUTIONS

Interroll Ltd
 Orion Way, Kettering, Northants, NN15 6NL
 General Enquiries: gb.sales@interroll.com
 Service Enquiries: uk.service@interroll.com
 T: 01536 312770 www.interroll.co.uk

CYLINDER SENSORS / ENCODERS

Baumer Limited
 33-36 Shrivensham Hundred Business Park, Majors Road, Watchfield, Swindon, Wiltshire, SN6 8TZ
 T: +44 1793 783 839 E: sales.uk@baumer.com
 www.baumer.com

ifm electronic Ltd
 Oldfield Road, Hampton, Middlesex TW12 2HD
 T: 020 8213-2222 E: enquiry.gb@ifm.com
 www.ifm.com/uk

SICK (UK) LTD
 Waldkirch House, 39 Hedley Rd, St Albans, Herts AL1 5BN
 T: 01727 831121 F: 01727 856767
 E: info@sick.co.uk www.sick.co.uk

Baumer Limited
 33-36 Shrivensham Hundred Business Park, Majors Road, Watchfield, Swindon, Wiltshire, SN6 8TZ
 T: +44 1793 783 839 E: sales.uk@baumer.com
 www.baumer.com

ifm electronic Ltd
 Oldfield Road, Hampton, Middlesex TW12 2HD
 T: 020 8213-2222 E: enquiry.gb@ifm.com
 www.ifm.com/uk

SICK (UK) LTD
 Waldkirch House, 39 Hedley Rd, St Albans, Herts AL1 5BN
 T: 01727 831121 F: 01727 856767
 E: info@sick.co.uk www.sick.co.uk

DESIGN SOFTWARE

PILZ Automation Technology
 Pilz House, Little Colliers Field, Corby, Northants, NN18 8TJ
 T: 01536 460766 E: sales@pilz.co.uk www.pilz.co.uk

DISTRIBUTED CONTROL SYSTEMS

PILZ Automation Technology
 Pilz House, Little Colliers Field, Corby, Northants, NN18 8TJ
 T: 01536 460766 E: sales@pilz.co.uk www.pilz.co.uk

ENCODERS

Baumer Limited
 33-36 Shrivensham Hundred Business Park, Majors Road, Watchfield, Swindon, Wiltshire, SN6 8TZ
 T: +44 1793 783 839 E: sales.uk@baumer.com
 www.baumer.com

ifm electronic Ltd
 Oldfield Road, Hampton, Middlesex TW12 2HD
 T: 020 8213-2222 E: enquiry.gb@ifm.com
 www.ifm.com/uk

SICK (UK) LTD
 Waldkirch House, 39 Hedley Rd, St Albans, Herts AL1 5BN
 T: 01727 831121 F: 01727 856767
 E: info@sick.co.uk www.sick.co.uk

ENERGY EFFICIENCY

Power Capacitors Birmingham, B11 2BH
 T: 07780 470457
 E: miked@powercapacitors.co.uk
 www.powercapacitors.co.uk

EX-HAZARDOUS AREA EQUIPMENT

MARECHAL ELECTRIC Saint-Maurice cedex
 Tel: +33 (0) 1 45 11 60 00
 E: contact@marechal.com
 www.marechal.com

FIELDBUS SYSTEMS

ifm electronic Ltd
 Oldfield Road, Hampton, Middlesex TW12 2HD
 T: 020 8213-2222 E: enquiry.gb@ifm.com
 www.ifm.com/uk

PILZ Automation Technology
 Pilz House, Little Colliers Field, Corby, Northants, NN18 8TJ
 T: 01536 460766 E: sales@pilz.co.uk www.pilz.co.uk

FILTERS - MAGNETIC

Goudsmit Magnetic Systems BV
 T: +31 (0)40 2213283
 E: info@goudsmit.eu
 www.goudsmitmagnets.com

FLOW SENSORS

Baumer Limited
 33-36 Shrivensham Hundred Business Park, Majors Road, Watchfield, Swindon, Wiltshire, SN6 8TZ
 T: +44 1793 783 839 E: sales.uk@baumer.com
 www.baumer.com

ifm electronic Ltd
 Oldfield Road, Hampton, Middlesex TW12 2HD
 T: 020 8213-2222 E: enquiry.gb@ifm.com
 www.ifm.com/uk

SICK (UK) LTD
 Waldkirch House, 39 Hedley Rd, St Albans, Herts AL1 5BN
 T: 01727 831121 F: 01727 856767
 E: info@sick.co.uk www.sick.co.uk

GEARED MOTORS

Lenze T: 01234 753200
 E: sales.uk@lenze.com
 www.lenze.com

HUMAN MACHINE INTERFACE

PILZ Automation Technology
 Pilz House, Little Colliers Field, Corby, Northants, NN18 8TJ
 T: 01536 460766 E: sales@pilz.co.uk www.pilz.co.uk

INDUCTIVE SENSORS

Baumer Limited
 33-36 Shrivensham Hundred Business Park, Majors Road, Watchfield, Swindon, Wiltshire, SN6 8TZ
 T: +44 1793 783 839 E: sales.uk@baumer.com
 www.baumer.com

ifm electronic Ltd
 Oldfield Road, Hampton, Middlesex TW12 2HD
 T: 020 8213-2222 E: enquiry.gb@ifm.com
 www.ifm.com/uk

SICK (UK) LTD
 Waldkirch House, 39 Hedley Rd, St Albans, Herts AL1 5BN
 T: 01727 831121 F: 01727 856767
 E: info@sick.co.uk www.sick.co.uk

INDUSTRIAL ENERGY SAVING

Power Capacitors Birmingham, B11 2BH
 T: 07780 470457
 E: miked@powercapacitors.co.uk
 www.powercapacitors.co.uk

IO-LINK

ifm electronic Ltd
 Oldfield Road, Hampton, Middlesex TW12 2HD
 T: 020 8213-2222 E: enquiry.gb@ifm.com
 www.ifm.com/uk

LEVEL SENSORS

Baumer Limited
 33-36 Shrivensham Hundred Business Park, Majors Road, Watchfield, Swindon, Wiltshire, SN6 8TZ
 T: +44 1793 783 839 E: sales.uk@baumer.com
 www.baumer.com

ifm electronic Ltd
 Oldfield Road, Hampton, Middlesex TW12 2HD
 T: 020 8213-2222 E: enquiry.gb@ifm.com
 www.ifm.com/uk

SICK (UK) LTD
 Waldkirch House, 39 Hedley Rd, St Albans, Herts AL1 5BN
 T: 01727 831121 F: 01727 856767
 E: info@sick.co.uk www.sick.co.uk

LINEAR MOTORS

Quin Systems Ltd
 Oaklands Park, Wokingham, RG41 2FD
 T: 0118 977 1077 E: sales@quin.co.uk www.quin.co.uk

MACHINE GUARDING SYSTEMS

ifm electronic Ltd
 Oldfield Road, Hampton, Middlesex TW12 2HD
 T: 020 8213-2222 E: enquiry.gb@ifm.com
 www.ifm.com/uk

PILZ Automation Technology
 Pilz House, Little Colliers Field, Corby, Northants, NN18 8TJ
 T: 01536 460766 E: sales@pilz.co.uk www.pilz.co.uk

MACHINE KNIVES & PUNCHES

SICK (UK) LTD
 Waldkirch House, 39 Hedley Rd, St Albans, Herts AL1 5BN
 T: 01727 831121 F: 01727 856767
 E: info@sick.co.uk www.sick.co.uk

MACHINE KNIVES & PUNCHES

Stellar Technik MACHINE KNIVES, PUNCHES & STS CUTTERS
 T: 01460 270600 E: enquiries@stellartechnik.com
 www.stellartechnik.com

FOOD PROCESSING EQUIPMENT

farleygreene
Unit 2, Hatch Industrial Park,
Greywell Road, Mapledurwell,
Hampshire RG24 7NG
T: +44 (0)1256 474 547
E: enquiries@farleygreene.com

Grote Company
Wrexham, LL13 7YP
www.grotecompany.com
E: sales@grotecompany.com
T: 01978 362243 F: 01978 362255

Holmach Ltd
Process solutions for industry
T: 01780 749097 E: sales@holmach.co.uk
www.holmach.co.uk

Packline Materials Handling
T: 01202 307700 E: info@packline.co.uk
www.packline.co.uk

ProXES UK & Ireland Ltd
T: +44 1480 400684
E: ukireland@proxes.com
W: proxes.com

Reiser UK Ltd
The Reiser Building,
Maidstone Rd, Kingston, Milton Keynes, MK10 0BD
T: 01908 585300 F: 01908 585400
E: salesuk@reiser.com www.reiser.com

Riggs Autopack Ltd
Nelson, Lancs BB9 0HU
T: 01282 440040
E: info@riggsautopack.co.uk
www.riggsautopack.co.uk

HEAT EXCHANGERS

Krones UK Ltd
Westregan House,
Great Bank Road, Wingates Industrial Park,
Westhoughton, Bolton BL5 3XB
T: 01942 845000 F: 01942 845091
E: sales@krones.co.uk www.krones.com

ProXES UK & Ireland Ltd
T: +44 1480 400684
E: ukireland@proxes.com
W: proxes.com

HIGH PRESSURE PROCESSING EQUIPMENT (HPP)

Holmach Ltd
T: 01780 749097 E: sales@holmach.co.uk
www.holmach.co.uk

HOMOGENISATION

ProXES UK & Ireland Ltd
T: +44 1480 400684
E: ukireland@proxes.com
W: proxes.com

Silverson Machines Ltd
Waterside, Chesham, Buckinghamshire HP5 1PQ
T: 01494 786331
E: sales@silverson.co.uk
www.silverson.co.uk

MEAT PROCESSING EQUIPMENT

CME Ltd
Combe St Nicholas, Somerset, TA20 3NL
T: 01460 269500
E: cme@cme-ltd.com
www.cme-ltd.com

Reiser UK Ltd
The Reiser Building,
Maidstone Rd, Kingston, Milton Keynes, MK10 0BD
T: 01908 585300 F: 01908 585400
E: salesuk@reiser.com www.reiser.com

MILLS

ProXES UK & Ireland Ltd
T: +44 1480 400684
E: ukireland@proxes.com
W: proxes.com

MINCING & GRINDING

Reiser UK Ltd
The Reiser Building,
Maidstone Rd, Kingston, Milton Keynes, MK10 0BD
T: 01908 585300 F: 01908 585400
E: salesuk@reiser.com www.reiser.com

MIXING MACHINES

J.R.Boone Ltd - Mixers
T: +44 (0)1260 272894
E: sales@jrboone.com
www.jrboone.com

ProXES UK & Ireland Ltd
T: +44 1480 400684
E: ukireland@proxes.com
W: proxes.com

Reiser UK Ltd
The Reiser Building,
Maidstone Rd, Kingston, Milton Keynes, MK10 0BD
T: 01908 585300 F: 01908 585400
E: salesuk@reiser.com www.reiser.com

Silverson Machines Ltd
Waterside, Chesham, Buckinghamshire HP5 1PQ
T: 01494 786331
E: sales@silverson.co.uk
www.silverson.co.uk

MIXING VESSELS

Adelphi Group
Mill Green Road, Haywards Heath,
West Sussex RH16 1XQ
T: 01444 472300
W: www.adelphi.co.uk

D.H. INDUSTRIES LIMITED
Sullivan House, Fenton Way, Laindon,
Essex, SS15 6TD, UK
T: +44 (0)1268 410 666 - F: +44 (0)1268 410 777
E: dh@dhi.co.uk - www.dhi.co.uk

ProXES UK & Ireland Ltd
T: +44 1480 400684
E: ukireland@proxes.com
W: proxes.com

PASTEURISERS

Holmach Ltd
T: 01780 749097 E: sales@holmach.co.uk
www.holmach.co.uk

KHS UK Limited
6 Monkspath Business Park,
Highlands Road, Shirley, Solihull, B90 4NY
T: 0121 713 6900 F: 0121 713 6935
E: info@khs.com www.khs.com

ProXES UK & Ireland Ltd
T: +44 1480 400684
E: ukireland@proxes.com
W: proxes.com

PHARMACEUTICAL PROCESSING

Baker Perkins Ltd
Manor Drive,
Peterborough, PE4 7AP T: +44 1733 283000
E: bpltd@bakerperkins.com
www.bakerperkins.com

CME Ltd
Combe St Nicholas, Somerset, TA20 3NL
T: 01460 269500
E: cme@cme-ltd.com
www.cme-ltd.com

Coperion K-Tron GB
4 Acom Business Park, Stockport, Cheshire, SK4 1AS
T: 0161 209 4810
E: ckb@coperionktron.com
www.coperion.com

farleygreene
Unit 2, Hatch Industrial Park,
Greywell Road, Mapledurwell,
Hampshire RG24 7NG
T: +44 (0)1256 474 547
E: enquiries@farleygreene.com

GRIPPLE AUTOMATION
info@grippleautomation.com
www.grippleautomation.com T: 0114 2800 830

Packline Materials Handling
T: 01202 307700 E: info@packline.co.uk
www.packline.co.uk

ProXES UK & Ireland Ltd
T: +44 1480 400684
E: ukireland@proxes.com
W: proxes.com

Multipond Limited
Genoa Way, High Wycombe, HP11 1NY
T: 01494 471580 F: 01494 533487
E: info@multipond.co.uk www.multipond.com

Reiser UK Ltd
The Reiser Building,
Maidstone Rd, Kingston, Milton Keynes, MK10 0BD
T: 01908 585300 F: 01908 585400
E: salesuk@reiser.com www.reiser.com

Steck Depositors Limited
Cophorne, West Sussex, RH10 3LF
T: +44 (0) 1293 873439
E: sales@steckdepositors.com
www.steckdepositors.com

PUMPS VACUUM

piab
Oaks Ind. Est., Festival Drive,
Loughborough, LE11 5XN
T: 01509 857010 F: 01509 857011
E: info-uk@piab.com www.piab.com

SANDWICH PREPARATION EQUIPMENT

Grote Company
Wrexham, LL13 7YP
www.grotecompany.com
E: sales@grotecompany.com
T: 01978 362243 F: 01978 362255

Reiser UK Ltd
The Reiser Building,
Maidstone Rd, Kingston, Milton Keynes, MK10 0BD
T: 01908 585300 F: 01908 585400
E: salesuk@reiser.com www.reiser.com

SAUSAGE PRODUCTION EQUIPMENT

Reiser UK Ltd
The Reiser Building,
Maidstone Rd, Kingston, Milton Keynes, MK10 0BD
T: 01908 585300 F: 01908 585400
E: salesuk@reiser.com www.reiser.com

Sealpac UK Ltd
Units 1-3, The Concept Centre,
Innovation Close, Poole, Dorset BH12 4QD, UK
T: 0845 302 3056 F: 0845 302 3057
E: sales@sealpac-uk.com www.sealpac-uk.com

SIEVES & SEPARATORS

farleygreene
Unit 2, Hatch Industrial Park,
Greywell Road, Mapledurwell,
Hampshire RG24 7NG
T: +44 (0)1256 474 547
E: enquiries@farleygreene.com

SLICING & DICING

Grote Company
Wrexham, LL13 7YP
www.grotecompany.com
E: sales@grotecompany.com
T: 01978 362243 F: 01978 362255

IXAPACK GLOBAL
T: +33 772 142 856
E: laurent.noiraud@ixapack.com
www.ixapack.com

Reiser UK Ltd
The Reiser Building,
Maidstone Rd, Kingston, Milton Keynes, MK10 0BD
T: 01908 585300 F: 01908 585400
E: salesuk@reiser.com www.reiser.com

Reiser UK Ltd
The Reiser Building,
Maidstone Rd, Kingston, Milton Keynes, MK10 0BD
T: 01908 585300 F: 01908 585400
E: salesuk@reiser.com www.reiser.com

Reiser UK Ltd
The Reiser Building,
Maidstone Rd, Kingston, Milton Keynes, MK10 0BD
T: 01908 585300 F: 01908 585400
E: salesuk@reiser.com www.reiser.com

Baker Perkins Ltd
Manor Drive,
Peterborough, PE4 7AP T: +44 1733 283000
E: bpltd@bakerperkins.com
www.bakerperkins.com

Reiser UK Ltd
The Reiser Building,
Maidstone Rd, Kingston, Milton Keynes, MK10 0BD
T: 01908 585300 F: 01908 585400
E: salesuk@reiser.com www.reiser.com

GRIPPLE AUTOMATION
info@grippleautomation.com
www.grippleautomation.com T: 0114 2800 830

Scorpion Vision Ltd
118 Gore Road, New Milton,
Hampshire BH25 6SJ
T: 01590 679333
E: sales@scorpionvision.com
www.scorpionvision.co.uk

SPECIAL PURPOSE MACHINES

GRIPPLE AUTOMATION
info@grippleautomation.com
www.grippleautomation.com T: 0114 2800 830

SEWTEC AUTOMATION
Automation House, Jane's Hill, Silkwood, Business Park,
Wakefield, West Yorkshire, WF5 9TG
T: 01924 494047 E: sales@sewtec.co.uk www.sewtec.co.uk

SPICE & HERB STERILISATION

Holmach Ltd
T: 01780 749097 E: sales@holmach.co.uk
www.holmach.co.uk

STERILISING TUNNELS

JenAct
T: +44 (0)1256 892194
E: jenact@jenton.co.uk
www.jenact.co.uk

Weber Packaging Solutions
Macmerry Industrial Estate,
Tranent, East Lothian, EH33 1HD
T: 01875 611 111 F: 01875 613 310
E: sales@weber.co.uk www.weber.co.uk

VACUUM PROCESS VESSELS

J.R.Boone Ltd - Mixers
T: +44 (0)1260 272894
E: sales@jrboone.com
www.jrboone.com

Holmach Ltd
T: 01780 749097 E: sales@holmach.co.uk
www.holmach.co.uk

ProXES UK & Ireland Ltd
T: +44 1480 400684
E: ukireland@proxes.com
W: proxes.com

VISCOSITY CONTROL

Jenton International Ltd
T: +44 (0)1256 892194
E: sales@jenton.co.uk
www.jenton.co.uk

X-RAY INSPECTION

Ishida Europe Ltd
Kettles Wood Drive,
Woodgate Business Park, Birmingham B32 3DB
T: 0121 607 7700 F: 0121 607 7666
E: info@ishidaeurope.com www.ishidaeurope.com

Sealpac UK Ltd
Units 1-3, The Concept Centre,
Innovation Close, Poole, Dorset BH12 4QD, UK
T: 0845 302 3056 F: 0845 302 3057
E: sales@sealpac-uk.com www.sealpac-uk.com

Sparc Systems Ltd
Malvern, Worcestershire, WR13 6NP
T: 01684 310000
E: sales@sparc-systems.co.uk
www.sparc-systems.co.uk

Karmelle Ltd
Unit 17, Queens Mill Industrial Estate,
Queens Mill Lane, Huddersfield HD1 3RR
T: 01484 533356
E: Karmelle@gmail.com www.karmelle.com

Optima Packaging Machinery PLC
7 Loader Close, Kings Worthy, Hampshire SO23 7TF
T: 01962 620898 F: +49 (0)791/506-6500
E: info@optima-gb.com
www.optima-gb.com

DICO
By Precision Automation
01795 551 500
ppma@prec.co.uk
PRECISIONAUTOMATION.CO.UK/PPMA

Propack Automation Machinery Ltd
10 Hill Wootton Rd, Leek Wootton, Warwicks, CV35 7QL
T: 02476 470074
E: office@propack.co.uk
www.propack.co.uk

Shemesh Automation UK Ltd
Berkeley Square, Mayfair,
London W1J 6DB T: +44 207 887 6004
E: SA@shemeshautomation.com
www.shemeshautomation.com

SP Filling Systems Ltd
Unit 28, Ddole Industrial Estate,
Llandrindod Wells, Powys LD1 6DF
T: 01597 824918 F: 01597 822553
E: sales@sp-filling.co.uk www.sp-filling.co.uk

CARTONING SYSTEMS

CAMA 3 Ltd
Suite 44, Berkeley House,
Hunts Rise, South Marston Park,
Swindon, Wilt, SN3 4TC
T: 01793 831111 F: 01793 831481
E: cama3@camagroup.com www.camagroup.com

CME Ltd
Combe St Nicholas, Somerset, TA20 3NL
T: 01460 269500
E: cme@cme-ld.com
www.cme-ld.com

ETPACK SPRINTER UK LTD
NEWBURY, BERKS, RG14 5SJ
T: 01635 905090
E: dianne@et-pack.com
www.et-pack.com

igluetech® Glueing Technology
Melksham, Wiltshire SN12 6TT
T: 01225 783456
E: general@igluetech.co.uk www.igluetech.co.uk

Jacob White Packaging Ltd
Riverside Way, Dartford, Kent DA1 5BY
T: 01322 272531 F: 01322 270692
E: enquiries@jacobwhite.com
www.jacobwhite.com

KEYMAC
PACKAGING SYSTEMS
28b Burnett Business Park,
Gypsy Lane, Keynsham,
Bristol BS31 2ED
T: 0117 986 5417
E: sales@keymac.co.uk www.keymac.co.uk

Kliklok International Ltd
Western Drive, Bristol BS14 0AY
E: Jason.Godwin@syntegon.com
T: 01275 557639
www.syntegon.com

Mpac Langen
+31 24 648 66 55
sales.emea@mpac-group.com
www.mpac-group.com

Optima Packaging Machinery PLC
7 Loader Close, Kings Worthy, Hampshire SO23 7TF
T: 01962 620898 F: +49 (0)791/506-6500
E: info@optima-gb.com
www.optima-gb.com

Propack Automation Machinery Ltd
10 Hill Wootton Rd, Leek Wootton, Warwicks, CV35 7QL
T: 02476 470074
E: office@propack.co.uk
www.propack.co.uk

RAUPACK
Machinery for Packaging and Assembly
105 Newdigate Road, Nottingham, NG16 1HN
T: 0115 875 9846
E: contact@raupack.co.uk www.raupack.co.uk

Rovema Packaging Machines Ltd
8 Merlin Centre, Gatehouse Close,
Aylesbury, Bucks HP19 8DP
T: 01296 310490 F: 01296 483440
E: sales@rovema.co.uk
www.rovema.com

CASE ERECTING/FILLING SEALING

ADPAK
PACKAGING SYSTEMS & FILMS
T: 01282 601444 E: sales@adpak.co.uk
www.adpakmachinerysystemsld.co.uk

Aetna UK Limited
Oakley, Bedford,
MK43 7TA
T: 01234 825050
E: sales.uk@robopac.com www.aetnagroup.co.uk

CAMA 3 Ltd
Suite 44, Berkeley House,
Hunts Rise, South Marston Park,
Swindon, Wilt, SN3 4TC
T: 01793 831111 F: 01793 831481
E: cama3@camagroup.com www.camagroup.com

CKF
T: 01452 728753
E: info@ckf.co.uk
THE AUTOMATIC SOLUTION www.ckf.co.uk

Endline Machinery Ltd
Biggleswade, SG18 8QB
T: 01767 316422
E: sales@endline-automation.com
www.endline-automation.com

ETT UK Limited
Beccles, Suffolk, NR34 7TD
T: 01502 470812
E: geoff@ett-uk.com
www.ett-uk.com

Evolution BPS
T: 01721 724296
E: sales@evolutionbps.co.uk
www.evolutionbps.co.uk

IXAPACK GLOBAL
T: +33 772 142 856
E: laurent.noiraud@ixapack.com
www.ixapack.com

Jacob White Packaging Ltd
Riverside Way, Dartford, Kent DA1 5BY
T: 01322 272531 F: 01322 270692
E: enquiries@jacobwhite.com
www.jacobwhite.com

Propack Automation Machinery Ltd
10 Hill Wootton Rd, Leek Wootton, Warwicks, CV35 7QL
T: 02476 470074
E: office@propack.co.uk
www.propack.co.uk

Quin Systems Ltd
Oaklands Park,
Wokingham, RG41 2FD
T: 0118 977 1077
E: sales@quin.co.uk www.quin.co.uk

SCM Handling Ltd
Broadgauge Business Park, Taunton,
Somerset, TA4 3RU
T: 01823 431838 F: 01823 430806
E: sales@scmhandling.com www.scmhandling.com

SEWTEC
AUTOMATION
Automation House, Jane's Hill, Silkwood, Business Park,
Wakefield, West Yorkshire, WF5 9TG
T: 01924 494047 E: sales@sewtec.co.uk www.sewtec.co.uk

Shemesh Automation UK Ltd
Berkeley Square, Mayfair,
London W1J 6DB T: +44 207 887 6004
E: SA@shemeshautomation.com
www.shemeshautomation.com

Siat.co.uk
PACKAGING MACHINES
Unit 3 Malory Road,
Beacon Park, Gorleston,
Great Yarmouth,
NR31 7DT
T: 01493 257070 E: info@siat.co.uk www.siat.co.uk

SOCO SYSTEM
SOCO SYSTEM (UK) Ltd
Unit 18, Palmerston Street, Hanley,
Stoke-On-Trent, Staffs, ST1 3EU
T: 01782 274100 F: 01782 272696
E: info@socosystem.co.uk
www.socosystem.com

Tekpak Automation Ltd (UK)
T: +44 (0)113 3505694
E: sales@tekpak.co.uk
www.tekpak.co.uk

WestRock
Unit 3 Malory Road, Beacon Park, Gorleston,
Great Yarmouth, NR31 7DT, UK T: 01493 257070
E: aps.uk@westrock.com www.westrock.com/automation-uk

CASE LINING/FILLING/CLOSING

Endline Machinery Ltd
Biggleswade, SG18 8QB
T: 01767 316422
E: sales@endline-automation.com
www.endline-automation.com

SEWTEC
AUTOMATION
Automation House, Jane's Hill, Silkwood, Business Park,
Wakefield, West Yorkshire, WF5 9TG
T: 01924 494047 E: sales@sewtec.co.uk www.sewtec.co.uk

WestRock
Unit 3 Malory Road, Beacon Park, Gorleston,
Great Yarmouth, NR31 7DT, UK T: 01493 257070
E: aps.uk@westrock.com www.westrock.com/automation-uk

CASE PACKERS AUTOMATIC

AMP
automation
T: +44 1427 611 969
E: sales@ampautomation.co.uk
www.ampautomation.co.uk

BW Integrated Systems
A Barry-Wehler Packaging Company
Doncaster, Yorkshire DN11 8EW
T: 01302 711056 E: sales@bwintegratedsystems.com
www.bwintegratedsystems.com

CAMA 3 Ltd
Suite 44, Berkeley House,
Hunts Rise, South Marston Park,
Swindon, Wilt, SN3 4TC
T: 01793 831111 F: 01793 831481
E: cama3@camagroup.com www.camagroup.com

CKF
T: 01452 728753
E: info@ckf.co.uk
THE AUTOMATIC SOLUTION www.ckf.co.uk

Endline Machinery Ltd
Biggleswade, SG18 8QB
T: 01767 316422
E: sales@endline-automation.com
www.endline-automation.com

ETT UK Limited
Beccles, Suffolk, NR34 7TD
T: 01502 470812
E: geoff@ett-uk.com
www.ett-uk.com

IXAPACK GLOBAL
T: +33 772 142 856
E: laurent.noiraud@ixapack.com
www.ixapack.com

Jacob White Packaging Ltd
Riverside Way, Dartford, Kent DA1 5BY
T: 01322 272531 F: 01322 270692
E: enquiries@jacobwhite.com
www.jacobwhite.com

KHS UK Limited
6 Monkspath Business Park,
Highlands Road, Shirley, Solihull, B90 4NY
T: 0121 713 6900 F: 0121 713 6935
E: info@khs.com www.khs.com

Mpac Langen
+1 905 670 7200
sales.americas@mpac-group.com
www.mpac-group.com

Penn Packaging Ltd
Harkstead Hall Barn,
Ipswich, Suffolk IP9 1DB
T: 01473 893990 www.penn-packaging.co.uk
E: email@penn-packaging.co.uk

Quin Systems Ltd
Oaklands Park,
Wokingham, RG41 2FD
T: 0118 977 1077
E: sales@quin.co.uk www.quin.co.uk

RM GROUP
E: sales@rmgroupuk.com
www.rmgroupuk.com
T: +44(0)1686 621704

Rovema Packaging Machines Ltd
8 Merlin Centre, Gatehouse Close,
Aylesbury, Bucks HP19 8DP
T: 01296 310490 F: 01296 483440
E: sales@rovema.co.uk
www.rovema.com

SEWTEC
AUTOMATION
Automation House, Jane's Hill, Silkwood, Business Park,
Wakefield, West Yorkshire, WF5 9TG
T: 01924 494047 E: sales@sewtec.co.uk www.sewtec.co.uk

Shemesh Automation UK Ltd
Berkeley Square, Mayfair,
London W1J 6DB T: +44 207 887 6004
E: SA@shemeshautomation.com
www.shemeshautomation.com

Siat.co.uk
PACKAGING MACHINES
Unit 3 Malory Road,
Beacon Park, Gorleston,
Great Yarmouth,
NR31 7DT
T: 01493 257070 E: info@siat.co.uk www.siat.co.uk

Tekpak Automation Ltd (UK)
T: +44 (0)113 3505694
E: sales@tekpak.co.uk
www.tekpak.co.uk

WestRock
Unit 3 Malory Road, Beacon Park, Gorleston,
Great Yarmouth, NR31 7DT, UK T: 01493 257070
E: aps.uk@westrock.com www.westrock.com/automation-uk

CASE TAPING/STRAPPING/GLUING

ADPAK
PACKAGING SYSTEMS & FILMS
T: 01282 601444 E: sales@adpak.co.uk
www.adpakmachinerysystemsld.co.uk

Aetna UK Limited
Oakley, Bedford,
MK43 7TA
T: 01234 825050
E: sales.uk@robopac.com www.aetnagroup.co.uk

Endline Machinery Ltd
Biggleswade, SG18 8QB
T: 01767 316422
E: sales@endline-automation.com
www.endline-automation.com

Nordson (U.K.) Ltd.
25 Faraday Road, Rabans Lane Industrial Area,
Aylesbury, HP19 8RY
T: 01296 610 140 F: 01296 610 175
E: sales@uk.nordson.com
www.nordson.co.uk/adhesives

SEWTEC
AUTOMATION
Automation House, Jane's Hill, Silkwood, Business Park,
Wakefield, West Yorkshire, WF5 9TG
T: 01924 494047 E: sales@sewtec.co.uk www.sewtec.co.uk

Siat.co.uk
PACKAGING MACHINES
Unit 3 Malory Road,
Beacon Park, Gorleston,
Great Yarmouth,
NR31 7DT
T: 01493 257070 E: info@siat.co.uk www.siat.co.uk

CENTRIFUGAL BOWL FEEDERS

SEWTEC
AUTOMATION
Automation House, Jane's Hill, Silkwood, Business Park,
Wakefield, West Yorkshire, WF5 9TG
T: 01924 494047 E: sales@sewtec.co.uk www.sewtec.co.uk

CHECKWEIGHER METAL DETECTOR COMBI UNITS

Anritsu Invisis Ltd
Unit 3, Scott Road, Luton,
LU3 3BF, UK
T: +44 (0)845 539 9729
www.anritsu.com/en-GB/invisis

IXAPACK GLOBAL
T: +33 772 142 856
E: laurent.noiraud@ixapack.com
www.ixapack.com

Sealpac UK Ltd SEALPAC UK
Units 1-3, The Concept Centre,
Innovation Close, Poole, Dorset BH12 4QD, UK
T: 0845 302 3056 F: 0845 302 3057
E: sales@sealpac-uk.com www.sealpac-uk.com

Sparc Systems Ltd
Malvern, Worcestershire, WR13 6NP
T: 01684 310000
E: sales@sparc-systems.co.uk
www.sparc-systems.co.uk

The Food Machinery Company Ltd
Rochester, Kent ME3 8RF
01634 272345
contact@foodmc.com
www.foodmc.co.uk

CHECKWEIGHERS

Anritsu Invisis Ltd
Unit 3, Scott Road, Luton,
LU3 3BF, UK
T: +44 (0)845 539 9729
www.anritsu.com/en-GB/invisis

Ishida Europe Ltd
Kettles Wood Drive,
Woodgate Business Park, Birmingham B32 3DB
T: 0121 607 7700 F: 0121 607 7666
E: info@ishidaeurope.com www.ishidaeurope.com

M.D.S. Ltd Metal Detection Services
St. Martins Studios, Greenbank Road,
Sale, Cheshire M33 5FL
T: Sales 0161 286 8755 F: 0161 286 8750
E: sales@mds.org.uk www.mds.org.uk

Reiser UK Ltd
The Reiser Building,
Maidstone Rd, Kingston, Milton Keynes, MK10 0BD
T: 01908 585300 F: 01908 585400
E: salesuk@reiser.com www.reiser.com

Sealpac UK Ltd SEALPAC UK
Units 1-3, The Concept Centre,
Innovation Close, Poole, Dorset BH12 4QD, UK
T: 0845 302 3056 F: 0845 302 3057
E: sales@sealpac-uk.com www.sealpac-uk.com

To advertise contact Robert Beswick T 020 8773 5527 E robert.beswick@ppma.co.uk Packaging Machinery

Sparc Systems Ltd
 Malvern, Worcestershire, WR13 6NP
 T: 01684 310000
 E: sales@sparc-systems.co.uk
 www.sparc-systems.co.uk

The Food Machinery Company Ltd
 Rochester, Kent ME3 8RF
 01634 272345
 contact@foodmc.com
 www.foodmc.co.uk

Yamato
 Leeds, LS11 5AL
 T: 0113 322 1546
 E: sales1@yamatoscale.co.uk
 www.yamatoscale.co.uk

CHECKWEIGHERS - COMBINATION

ixAPACK GLOBAL
 T: +33 772 142 856
 E: laurent.noiraud@ixapack.com
 www.ixapack.com

M.D.S. Ltd Metal Detection Services
 St. Martins Studios, Greenbank Road,
 Sale, Cheshire M33 5PL
 T: Sales 0161 286 8755 F: 0161 286 8750
 E: sales@mds.org.uk www.mds.org.uk

Sealpac UK Ltd **SEALPAC UK**
 Units 1-3, The Concept Centre,
 Innovation Close, Poole, Dorset BH12 4QD, UK
 T: 0845 302 3056 F: 0845 302 3057
 E: sales@sealpac-uk.com www.sealpac-uk.com

CODING & MARKING

ALS Advanced Labelling Systems Limited
 Unit B, Bandet Way, Thame, Oxon, OX9 3SJ
 T: 01844 213177 www.als-uk.com

ATD Marking Systems
 Marley House, The Mill, Great Bowden Road,
 Market Harborough, Leicestershire, LE16 7DE
 T: 01858 461014 F: 01858 436900
 E: mail@atduk.com www.atduk.com

Atwell self-adhesive Labellers
 T: 01444 239970
 E: sales@atwell-labellers.co.uk www.labeller.co.uk

Clearmark Solutions (ICE)
 Nottingham NG15 0DP
 T: 01159 640144
 E: enquiries@uk.interactivecoding.com
 www.interactivecoding.co.uk

Domino UK Ltd
 Bar Hill, Cambridge CB23 8TU
 T: 01954 782551 E: enquiries@domino-uk.com
 www.domino-uk.com

Industrial Labelling Systems Ltd
 D4 Brookside Business Park, Manchester M24 1GS
 T: 0161 655 4846
 E: sales@ilsystems.co.uk
 www.ilsystems.co.uk

Linx Printing Technologies Ltd
 St. Ives, PE27 5JL
 T: 01480 302661
 E: uksales@linx.co.uk www.linx.co.uk

Open Date Equipment Ltd
 Mitcham, Surrey CR4 4DG
 T: 020 8655 4999
 E: sales@opendate.co.uk
 www.opendate.co.uk

PrintSafe
 T: 01962 761761 E: sales@printsafe.co.uk
 www.printsafe.co.uk

Rotech Machines Limited
 Hertfordshire AL7 1AJ
 T: +44 (0) 1707 393700
 E: sales@rotechmachines.com
 www.rotechmachines.com

SEWTEC AUTOMATION
 Automation House, Jane's Hill, Silkwood, Business Park,
 Wakefield, West Yorkshire, WF5 9TG
 T: 01924 494047 E: sales@sewtec.co.uk www.sewtec.co.uk

Sojet www.t-mark.co.uk
 email: sales@t-mark.co.uk
 call: 0870 803 1877

Weber Packaging Solutions **Weber**
 Macmerry Industrial Estate,
 Tranent, East Lothian, EH33 1HD
 T: 01875 611 111 F: 01875 613 310
 E: sales@weber.co.uk www.weber.co.uk

CODING MANAGEMENT SOFTWARE

SEWTEC AUTOMATION
 Automation House, Jane's Hill, Silkwood, Business Park,
 Wakefield, West Yorkshire, WF5 9TG
 T: 01924 494047 E: sales@sewtec.co.uk www.sewtec.co.uk

COLLATING EQUIPMENT

CME Ltd
 Combe St Nicholas, Somerset, TA20 3NL
 T: 01460 269500
 E: cme@cme-ltd.com
 www.cme-ltd.com

SEWTEC AUTOMATION
 Automation House, Jane's Hill, Silkwood, Business Park,
 Wakefield, West Yorkshire, WF5 9TG
 T: 01924 494047 E: sales@sewtec.co.uk www.sewtec.co.uk

CONFECTIONERY WRAPPING MACHINES

CME Ltd
 Combe St Nicholas, Somerset, TA20 3NL
 T: 01460 269500
 E: cme@cme-ltd.com
 www.cme-ltd.com

Paramount Packaging Systems **PARAMOUNT**
 T: 01252 815252
 E: fuji@paramount-packaging.co.uk
 www.paramount-packaging.co.uk

CONTRACT LABELLING

ALS Advanced Labelling Systems Limited
 Unit B, Bandet Way, Thame, Oxon, OX9 3SJ
 T: 01844 213177 www.als-uk.com

Atwell self-adhesive Labellers
 T: 01444 239970
 E: sales@atwell-labellers.co.uk www.labeller.co.uk

Premier Labellers
 British Manufactured Labelling Machinery T: 01255 553822
 E: sales@premierlabellers.co.uk www.premierlabellers.co.uk

CONVERGERS

Atwell self-adhesive Labellers
 T: 01444 239970
 E: sales@atwell-labellers.co.uk www.labeller.co.uk

Jenton Ariana
 T: +44 (0)1256 892194
 E: sales@jenton.co.uk
 www.jentonariana.co.uk

Kensal Handling Systems
 Kensal House, President Way,
 Luton, LU2 9NR
 T: +44 (0) 1 582 425 777 F: +44 (0) 1 582 425 776
 E: sales@kensal.com www.kensal.com

SEWTEC AUTOMATION
 Automation House, Jane's Hill, Silkwood, Business Park,
 Wakefield, West Yorkshire, WF5 9TG
 T: 01924 494047 E: sales@sewtec.co.uk www.sewtec.co.uk

CONVEYORS

Advance Automated Systems Ltd
 T: 01325 328930
 E: sales@advance-as.co.uk
 www.advanceconveyors.co.uk

Astec Conveyors
 Robian Way, Swadlincote, Derbyshire DE11 9DH
 T: 01283 210333 F: 01283 210444
 E: Sales@Astecconveyors.com
 www.astecconveyors.com

BW Integrated Systems
 A Barry-Wehmiller Packaging Company
 Doncaster, Yorkshire DN11 8EW
 T: 01302 711056 E: sales@bwintegratedsystems.com
 www.bwintegratedsystems.com

Cap Coder Ltd **CapCoder**
 Monument Business Park,
 Chalgrove, Oxford, OX44 7RW
 T: 01865 891466
 E: sales@capcoder.com www.capcoder.com

CKF T: 01452 728753
 E: info@ckf.co.uk
 THE AUTOMATIC SOLUTION www.ckf.co.uk

endoline ROBOTICS
 T: +44 (0)1767 310581 E: sales@endline-robotics.com
 www.endline-robotics.com

Fischbein-Saxon Ltd **FISCHBEIN**
 T: +44 (0) 844 372 2877
 E: sales@fischbein-saxon.co.uk
 www.fischbein.com/eastern

FlexLink Systems Limited
 Milton Keynes, MK14 5BN
 T: 01908 327200
 E: info.uk@flexlink.com
 www.flexlink.com

Interroll Ltd
 Orion Way, Kettering,
 Northants, NN15 6NL
 General Enquiries: gb.sales@interroll.com
 Service Enquiries: uk.service@interroll.com
 T: 01536 312770 www.interroll.co.uk

Kensal Handling Systems
 Kensal House, President Way,
 Luton, LU2 9NR
 T: +44 (0) 1 582 425 777 F: +44 (0) 1 582 425 776
 E: sales@kensal.com www.kensal.com

piab
 Oaks Ind. Est., Festival Drive,
 Loughborough, LE11 5XN
 T: 01509 857010 F: 01509 857011
 E: info-uk@piab.com www.piab.com

RMGROUP E: sales@rmgroupuk.com
 www.rmgroupuk.com
 T: +44(0)1686 621704

SCM Handling Ltd
 Broadgauge Business Park, Taunton,
 Somerset, TA4 3RU
 T: 01823 431838 F: 01823 430806
 E: sales@scmhandling.com www.scmhandling.com

SEWTEC AUTOMATION
 Automation House, Jane's Hill, Silkwood, Business Park,
 Wakefield, West Yorkshire, WF5 9TG
 T: 01924 494047 E: sales@sewtec.co.uk www.sewtec.co.uk

Shemesh Automation UK Ltd
 Berkeley Square, Mayfair,
 London W1J 6DB T: +44 207 887 6004
 E: SA@shemeshautomation.com
 www.shemeshautomation.com

The Food Machinery Company Ltd
 Rochester, Kent ME3 8RF
 01634 272345
 contact@foodmc.com
 www.foodmc.co.uk

Weber Packaging Solutions **Weber**
 Macmerry Industrial Estate,
 Tranent, East Lothian, EH33 1HD
 T: 01875 611 111 F: 01875 613 310
 E: sales@weber.co.uk www.weber.co.uk

CONVEYORS (AIR)

SEWTEC AUTOMATION
 Automation House, Jane's Hill, Silkwood, Business Park,
 Wakefield, West Yorkshire, WF5 9TG
 T: 01924 494047 E: sales@sewtec.co.uk www.sewtec.co.uk

CONVEYORS - MOTORISED DRUMS

Interroll Ltd
 Orion Way, Kettering,
 Northants, NN15 6NL
 General Enquiries: gb.sales@interroll.com
 Service Enquiries: uk.service@interroll.com
 T: 01536 312770 www.interroll.co.uk

CONVEYORS - PALLET

Astec Conveyors
 Robian Way, Swadlincote, Derbyshire DE11 9DH
 T: 01283 210333 F: 01283 210444
 E: Sales@Astecconveyors.com
 www.astecconveyors.com

CKF T: 01452 728753
 E: info@ckf.co.uk
 THE AUTOMATIC SOLUTION www.ckf.co.uk

CSL T: 01283 552255
 E: sales@conveyorsystemsltd.co.uk
 www.conveyorsystemsltd.co.uk

Kensal Handling Systems **Kensal**
 Kensal House, President Way,
 Luton, LU2 9NR
 T: +44 (0) 1 582 425 777 F: +44 (0) 1 582 425 776
 E: sales@kensal.com www.kensal.com

RMGROUP E: sales@rmgroupuk.com
 www.rmgroupuk.com
 T: +44(0)1686 621704

Scott Automation Ltd (Alvey)
 T: +44 1925 426 001
 E: info@scottautomation.co.uk
 www.scottautomation.co.uk

CONVEYORS - POWERED ROLLER

Astec Conveyors
 Robian Way, Swadlincote, Derbyshire DE11 9DH
 T: 01283 210333 F: 01283 210444
 E: Sales@Astecconveyors.com
 www.astecconveyors.com

CKF T: 01452 728753
 E: info@ckf.co.uk
 THE AUTOMATIC SOLUTION www.ckf.co.uk

CORRUGATED CASE MAKING

SEWTEC AUTOMATION
 Automation House, Jane's Hill, Silkwood, Business Park,
 Wakefield, West Yorkshire, WF5 9TG
 T: 01924 494047 E: sales@sewtec.co.uk www.sewtec.co.uk

COUNTING MACHINERY

RAUPACK
 Machinery for Packaging and Assembly
 105 Newdigate Road, Nottingham, NG16 1HN
 T: 0115 875 9846
 E: contact@raupack.co.uk www.raupack.co.uk

Sparc Systems Ltd
 Malvern, Worcestershire, WR13 6NP
 T: 01684 310000
 E: sales@sparc-systems.co.uk
 www.sparc-systems.co.uk

COUNTING/PACKAGING HARDWARE COMPONENTS

Gainsborough Engineering Company
 Long Wood Road, Corringham Road Industrial Estate,
 Gainsborough, DN21 1QB
 T: 01427 617677
 F: 01427 810443
 E: sales@gains-eng.co.uk
 www.gains-eng.co.uk

GRIPPLE AUTOMATION
 info@grippleautomation.com
 www.grippleautomation.com T: 0114 2800 830

Riley Automation
 E: sales@rileyautomation.com
 T: 01332 275850 www.rileyautomation.com

SEWTEC AUTOMATION
 Automation House, Jane's Hill, Silkwood, Business Park,
 Wakefield, West Yorkshire, WF5 9TG
 T: 01924 494047 E: sales@sewtec.co.uk www.sewtec.co.uk

Weber Packaging Solutions **Weber**
 Macmerry Industrial Estate,
 Tranent, East Lothian, EH33 1HD
 T: 01875 611 111 F: 01875 613 310
 E: sales@weber.co.uk www.weber.co.uk

CRIMPING EQUIPMENT

dh **D.H. INDUSTRIES LIMITED**
 Sullivan House, Fenton Way, Laindon,
 Essex, SS15 6TD, UK
 T: +44 (0)1268 410 666 F: +44 (0)1268 410 777
 E: dh@dhi.co.uk www.dhi.co.uk

GRIPPLE AUTOMATION
 info@grippleautomation.com
 www.grippleautomation.com T: 0114 2800 830

Shemesh Automation UK Ltd
 Berkeley Square, Mayfair,
 London W1J 6DB T: +44 207 887 6004
 E: SA@shemeshautomation.com
 www.shemeshautomation.com

DEPALLETISERS

ADPAK 30 YEARS
PACKAGING SYSTEMS & FILMS
T: 01282 601444 E: sales@adpak.co.uk
www.adpakmachinerysystemsLtd.co.uk

Autopack Ltd
Unit 6, Twyford Court, Rotherwas Industrial Estate, Hereford HR2 6JR
T: 01432 800 377 E: info@auto-pack.co.uk
www.auto-pack.co.uk

CKF T: 01452 728753
E: info@ckf.co.uk
THE AUTOMATIC SOLUTION www.ckf.co.uk

Endoline ROBOTICS
T: +44 (0)1767 310581 E: sales@endoline-robotics.com
www.endoline-robotics.com

ETT UK Limited
Beccles, Suffolk, NR34 7TD
T: 01502 470812 E: geoff@ett-uk.com
www.ett-uk.com

Kensal Handling Systems
Kensal House, President Way, Luton, LU2 9NR
T: +44 (0) 1582 425 777 F: +44 (0) 1582 425 776
E: sales@kensal.com www.kensal.com

KHS UK Limited
6 Monkspath Business Park, Highlands Road, Shirley, Solihull, B90 4NY
T: 0121 713 6900 F: 0121 713 6935
E: info@khs.com www.khs.com

RMGROUP
E: sales@rmgroupuk.com
www.rmgroupuk.com
T: +44(0)1686 621704

SCM Handling Ltd
Broadgauge Business Park, Taunton, Somerset, TA4 3RU
T: 01823 431838 F: 01823 430806
E: sales@scmhandling.com www.scmhandling.com

SEWTEC AUTOMATION
Automation House, Jane's Hill, Silkwood, Business Park, Wakefield, West Yorkshire, WF5 9TG
T: 01924 494047 E: sales@sewtec.co.uk www.sewtec.co.uk

STATEC BINDER GmbH
Industriestrasse 32, 8200 Gleisdorf, Austria. T: +43 3112 38580-0
E: office@statec-binder.com
www.statec-binder.com

ELEVATORS

CKF T: 01452 728753
E: info@ckf.co.uk
THE AUTOMATIC SOLUTION www.ckf.co.uk

Kensal Handling Systems
Kensal House, President Way, Luton, LU2 9NR
T: +44 (0) 1582 425 777 F: +44 (0) 1582 425 776
E: sales@kensal.com www.kensal.com

Riley Automation
E: sales@rileyautomation.com
T: 01332 275850 www.rileyautomation.com

SCM Handling Ltd
Broadgauge Business Park, Taunton, Somerset, TA4 3RU
T: 01823 431838 F: 01823 430806
E: sales@scmhandling.com www.scmhandling.com

SEWTEC AUTOMATION
Automation House, Jane's Hill, Silkwood, Business Park, Wakefield, West Yorkshire, WF5 9TG
T: 01924 494047 E: sales@sewtec.co.uk www.sewtec.co.uk

END OF LINE BAGGING MACHINES

ADPAK 30 YEARS
PACKAGING SYSTEMS & FILMS
T: 01282 601444 E: sales@adpak.co.uk
www.adpakmachinerysystemsLtd.co.uk

STATEC BINDER GmbH
Industriestrasse 32, 8200 Gleisdorf, Austria. T: +43 3112 38580-0
E: office@statec-binder.com
www.statec-binder.com

FFS HORIZONTAL (FLOWWRAPPERS)

BW Flexible Systems
A Barry-Wehmillier Packaging Company
Nottingham, NG9 1PF, United Kingdom
T: 0115 967 8787 E: sales@bwflexiblesystems.com
www.bwflexiblesystems.com

Ilapak Ltd
Uxbridge, Middlesex
UB8 2YF
T: 020 8797 2000
E: sales@ilapak.co.uk www.ilapak.com

Optima Packaging Machinery PLC
7 Loader Close, Kings Worthy, Hampshire SO23 7TF
T: 01962 620898 F: +49 (0)791/506-6500
E: info@optima-gb.com
www.optima-gb.com

Paramount Packaging Systems
PARAMOUNT PACKAGING SYSTEMS LTD
FUJII
T: 01252 815252
E: fuji@paramount-packaging.co.uk
www.paramount-packaging.co.uk

pfm packaging machinery
PFM House, 2 Pilgrim Way, Leeds LS28 6LU
T: +44 (0)113 2393401
E: sales@pfmuk.com
www.pfmuk.com

The Food Machinery Company Ltd
Rochester, Kent ME3 8RF
01634 272345
contact@foodmc.com
www.foodmc.co.uk

FFS POUCH MACHINERY

Penn Packaging Ltd
Harkstead Hall Barn, Ipswich, Suffolk IP9 1DB
T: 01473 893990 www.penn-packaging.co.uk
E: email@penn-packaging.co.uk

FFS THERMO

Reiser UK Ltd
The Reiser Building, Maidstone Rd, Kingston, Milton Keynes, MK10 0BD
T: 01908 585300 F: 01908 585400
E: salesuk@reiser.com www.reiser.com

FFS VERTICAL

Autopack Ltd
Unit 6, Twyford Court, Rotherwas Industrial Estate, Hereford HR2 6JR
T: 01432 800 377
E: info@auto-pack.co.uk
www.auto-pack.co.uk

BW Flexible Systems
A Barry-Wehmillier Packaging Company
Nottingham, NG9 1PF, United Kingdom
T: 0115 967 8787 E: sales@bwflexiblesystems.com
www.bwflexiblesystems.com

Gainsborough Engineering Company
Long Wood Road, Corringham Road Industrial Estate, Gainsborough, DN21 1QB
T: 01427 617677
F: 01427 810443
E: sales@gains-eng.co.uk
www.gains-eng.co.uk

Gainsborough Industrial Controls Ltd
Alpha Works, Sandars Road, Heapham Road Industrial Estate, Gainsborough DN21 1RZ
T: 01427 611885
E: sales@gic.uk.net www.gic.uk.net

Ilapak Ltd
Uxbridge, Middlesex
UB8 2YF
T: 020 8797 2000
E: sales@ilapak.co.uk www.ilapak.com

Line Equipment Ltd
Nottingham, NG16 3SU
T: 01773 717007
E: machines@lineequipment.co.uk
www.lineequipment.co.uk

pfm packaging machinery
PFM House, 2 Pilgrim Way, Leeds LS28 6LU
T: +44 (0)113 2393401
E: sales@pfmuk.com
www.pfmuk.com

RMGROUP
E: sales@rmgroupuk.com
www.rmgroupuk.com
T: +44(0)1686 621704

Rovema Packaging Machines Ltd
8 Merlin Centre, Gatehouse Close, Aylesbury, Bucks HP19 8DP
T: 01296 310490 F: 01296 483440
E: sales@rovema.co.uk
www.rovema.com

STATEC BINDER GmbH
Industriestrasse 32, 8200 Gleisdorf, Austria. T: +43 3112 38580-0
E: office@statec-binder.com
www.statec-binder.com

The Food Machinery Company Ltd
Rochester, Kent ME3 8RF
01634 272345
contact@foodmc.com
www.foodmc.co.uk

FILL & SEAL MACHINES

GRUNWALD UK Dosing · Filling · Packing
E: info@grunwald-uk.com
www.grunwald-uk.com
T: 01529 414999

Made in the UK by:
GRAVFIL Precision Automation **DICO**
01795 551500 • ppma@prec.co.uk
PRECISIONAUTOMATION.CO.UK/PPMA

Sealpac UK Ltd SEALPAC UK
Units 1-3, The Concept Centre, Innovation Close, Poole, Dorset BH12 4QD, UK
T: 0845 302 3056 F: 0845 302 3057
E: sales@sealpac-uk.com www.sealpac-uk.com

STATEC BINDER GmbH
Industriestrasse 32, 8200 Gleisdorf, Austria. T: +43 3112 38580-0
E: office@statec-binder.com
www.statec-binder.com

FILLING: ASEPTIC

Evolution BPS
T: 01721 724296
E: sales@evolutionbps.co.uk
www.evolutionbps.co.uk

Holmach Ltd
Process solutions for Industry
T: 01780 749097 E: sales@holmach.co.uk
www.holmach.co.uk

FILLING: BAG/SACK

All-Fill International Ltd
5 Gateshead Close, Sunderland Rd, Sandy, Bedfordshire SG19 1RS
T: 01767 691100
E: info@allfill.co.uk www.allfill.co.uk

BW Flexible Systems
A Barry-Wehmillier Packaging Company
Nottingham, NG9 1PF, United Kingdom
T: 0115 967 8787 E: sales@bwflexiblesystems.com
www.bwflexiblesystems.com

Fischbein-Saxon Ltd FISCHBEIN
A DURAVANT COMPANY
T: +44 (0) 844 372 2877
E: sales@fischbein-saxon.co.uk
www.fischbein.com/eastern

Ilapak Ltd
Uxbridge, Middlesex
UB8 2YF
T: 020 8797 2000
E: sales@ilapak.co.uk www.ilapak.com

Line Equipment Ltd
Nottingham, NG16 3SU
T: 01773 717007
E: machines@lineequipment.co.uk
www.lineequipment.co.uk

Optima Packaging Machinery PLC
7 Loader Close, Kings Worthy, Hampshire SO23 7TF
T: 01962 620898 F: +49 (0)791/506-6500
E: info@optima-gb.com
www.optima-gb.com

RMGROUP
E: sales@rmgroupuk.com
www.rmgroupuk.com
T: +44(0)1686 621704

Sealpac UK Ltd SEALPAC UK
Units 1-3, The Concept Centre, Innovation Close, Poole, Dorset BH12 4QD, UK
T: 0845 302 3056 F: 0845 302 3057
E: sales@sealpac-uk.com www.sealpac-uk.com

STATEC BINDER GmbH
Industriestrasse 32, 8200 Gleisdorf, Austria. T: +43 3112 38580-0
E: office@statec-binder.com
www.statec-binder.com

FILLING: BEVERAGE

Sealpac UK Ltd SEALPAC UK
Units 1-3, The Concept Centre, Innovation Close, Poole, Dorset BH12 4QD, UK
T: 0845 302 3056 F: 0845 302 3057
E: sales@sealpac-uk.com www.sealpac-uk.com

FILLING: CAPSULE

Adelphi Group
Mill Green Road, Haywards Heath, West Sussex RH16 1XQ
T: 01444 472300
W: www.adelphi.uk.com

Evolution BPS
T: 01721 724296
E: sales@evolutionbps.co.uk
www.evolutionbps.co.uk

FILLING: COSMETIC EQUIPMENT

All-Fill International Ltd
5 Gateshead Close, Sunderland Rd, Sandy, Bedfordshire SG19 1RS
T: 01767 691100
E: info@allfill.co.uk www.allfill.co.uk

Evolution BPS
T: 01721 724296
E: sales@evolutionbps.co.uk
www.evolutionbps.co.uk

Hi-Tech MACHINERY LIMITED
PRECISION IS EVERYTHING
T: +44 1256 766003 E: sales@fillers.co.uk www.fillers.co.uk

Holmach Ltd
Process solutions for Industry
T: 01780 749097 E: sales@holmach.co.uk
www.holmach.co.uk

Optima Packaging Machinery PLC
7 Loader Close, Kings Worthy, Hampshire SO23 7TF
T: 01962 620898 F: +49 (0)791/506-6500
E: info@optima-gb.com
www.optima-gb.com

Propack Automation Machinery Ltd
10 Hill Wootton Rd, Leek Wootton, Warwicks, CV35 7QL
T: 02476 470074
E: office@propack.co.uk
www.propack.co.uk

Shemesh Automation UK Ltd
Berkeley Square, Mayfair, London W1J 6DB T: +44 207 887 6004
E: SA@shemeshautomation.com
www.shemeshautomation.com

FILLING: DRUM & IBC

Adelphi Group
Mill Green Road, Haywards Heath, West Sussex RH16 1XQ
T: 01444 472300
W: www.adelphi.uk.com

Holmach Ltd
Process solutions for Industry
T: 01780 749097 E: sales@holmach.co.uk
www.holmach.co.uk

Karmelle Ltd
Unit 17, Queens Mill Industrial Estate, Queens Mill Lane, Huddersfield HD1 3RR
T: 01484 533356
E: Karmelle@gmail.com www.karmelle.com

SP Filling Systems Ltd
Unit 28, Ddole Industrial Estate, Llandindrod Wells, Powys LD1 6DF
T: 01597 824918 F: 01597 822553
E: sales@sp-filling.co.uk www.sp-filling.co.uk

STATEC BINDER GmbH
Industriestrasse 32, 8200 Gleisdorf, Austria. T: +43 3112 38580-0
E: office@statec-binder.com
www.statec-binder.com

FILLING: GRANULES

All-Fill International Ltd
5 Gateshead Close, Sunderland Rd, Sandy, Bedfordshire SG19 1RS
T: 01767 691100
E: info@allfill.co.uk www.allfill.co.uk

Optima Packaging Machinery PLC
7 Loader Close, Kings Worthy, Hampshire SO23 7TF
T: 01962 620898 F: +49 (0)791/506-6500
E: info@optima-gb.com
www.optima-gb.com

STATEC BINDER GmbH
Industriestrasse 32, 8200 Gleisdorf, Austria. T: +43 3112 38580-0
E: office@statec-binder.com
www.statec-binder.com

FILLING: LIQUID

Adelphi Group
Mill Green Road, Haywards Heath, West Sussex RH16 1XQ
T: 01444 472300
W: www.adelphi.uk.com

Autopack Ltd
Unit 6, Twyford Court, Rotherwas Industrial Estate, Hereford HR2 6JR
T: 01432 800 377
E: info@auto-pack.co.uk
www.auto-pack.co.uk

To advertise contact Robert Beswick **T** 020 8773 5527 **E** robert.beswick@ppma.co.uk **Packaging Machinery**

BW Integrated Systems
A Barry-Wehmler Packaging Company
Doncaster, Yorkshire DN11 8EW
T: 01302 711056 E: sales@bwintegratedsystems.com
www.bwintegratedsystems.com

Cap Coder Ltd
Monument Business Park,
Chalgrove, Oxford, OX44 7RW
T: 01865 891466
E: sales@capcoder.com www.capcoder.com

Evolution BPS
T: 01721 724296
E: sales@evolutionbps.co.uk
www.evolutionbps.co.uk

Hi-Tech Machinery Limited
PRECISION IS EVERYTHING
T: +44 1256 766003 E: sales@fillers.co.uk www.fillers.co.uk

Holmach Ltd
Process solutions for industry
T: 01780 749097 E: sales@holmach.co.uk
www.holmach.co.uk

Karmelle Ltd
Unit 17, Queens Mill Industrial Estate,
Queens Mill Lane, Huddersfield HD1 3RR
T: 01484 533356
E: Karmelle@gmail.com www.karmelle.com

KHS UK Limited
6 Monkspath Business Park,
Highlands Road, Shirley, Solihull, B90 4NY
T: 0121 713 6900 F: 0121 713 6935
E: info@khs.com www.khs.com

Optima Packaging Machinery PLC
7 Loader Close, Kings Worthy, Hampshire SO23 7TF
T: 01962 620898 F: +49 (0)791/506-6500
E: info@optima-gb.com
www.optima-gb.com

GRAVFIL
By Precision Automation
01795 551500
ppma@prec.co.uk
PRECISIONAUTOMATION.CO.UK/PPMA

RAUPACK
Machinery for Packaging and Assembly
105 Newdigate Road, Nottingham, NG16 1HN
T: 0115 875 9846
E: contact@raupack.co.uk www.raupack.co.uk

Riggs Autopack Ltd
Nelson, Lancs BB9 0HU
T: 01282 440040
E: info@riggsautopack.co.uk
www.riggsautopack.co.uk

Shemesh Automation UK Ltd
Berkeley Square, Mayfair,
London W1J 6DB T: +44 207 887 6004
E: SA@shemeshautomation.com
www.shemeshautomation.com

SP Filling Systems Ltd
Unit 28, Ddole Industrial Estate,
Llandrindod Wells, Powys LD1 6DF
T: 01597 824918 F: 01597 822553
E: sales@sp-filling.co.uk www.sp-filling.co.uk

Hi-Tech Machinery Limited
PRECISION IS EVERYTHING
T: +44 1256 766003 E: sales@fillers.co.uk www.fillers.co.uk

SP Filling Systems Ltd
Unit 28, Ddole Industrial Estate,
Llandrindod Wells, Powys LD1 6DF
T: 01597 824918 F: 01597 822553
E: sales@sp-filling.co.uk www.sp-filling.co.uk

Adelphi Group
Mill Green Road, Haywards Heath,
West Sussex RH16 1XQ
T: 01444 472300
W: www.adelphi.uk.com

All-Fill International Ltd
5 Gateshead Close, Sunderland Rd,
Sandy, Bedfordshire SG19 1RS
T: 01767 691100
E: info@allfill.co.uk www.allfill.co.uk

Optima Packaging Machinery PLC
7 Loader Close, Kings Worthy, Hampshire SO23 7TF
T: 01962 620898 F: +49 (0)791/506-6500
E: info@optima-gb.com
www.optima-gb.com

Riggs Autopack Ltd
Nelson, Lancs BB9 0HU
T: 01282 440040
E: info@riggsautopack.co.uk
www.riggsautopack.co.uk

FILLING: PHARMACEUTICAL
Adelphi Group
Mill Green Road, Haywards Heath,
West Sussex RH16 1XQ
T: 01444 472300
W: www.adelphi.uk.com

All-Fill International Ltd
5 Gateshead Close, Sunderland Rd,
Sandy, Bedfordshire SG19 1RS
T: 01767 691100
E: info@allfill.co.uk www.allfill.co.uk

Cap Coder Ltd
Monument Business Park,
Chalgrove, Oxford, OX44 7RW
T: 01865 891466
E: sales@capcoder.com www.capcoder.com

Hi-Tech Machinery Limited
PRECISION IS EVERYTHING
T: +44 1256 766003 E: sales@fillers.co.uk www.fillers.co.uk

Optima Packaging Machinery PLC
7 Loader Close, Kings Worthy, Hampshire SO23 7TF
T: 01962 620898 F: +49 (0)791/506-6500
E: info@optima-gb.com
www.optima-gb.com

Shemesh Automation UK Ltd
Berkeley Square, Mayfair,
London W1J 6DB T: +44 207 887 6004
E: SA@shemeshautomation.com
www.shemeshautomation.com

SP Filling Systems Ltd
Unit 28, Ddole Industrial Estate,
Llandrindod Wells, Powys LD1 6DF
T: 01597 824918 F: 01597 822553
E: sales@sp-filling.co.uk www.sp-filling.co.uk

FILLING: POWDER

All-Fill International Ltd
5 Gateshead Close, Sunderland Rd,
Sandy, Bedfordshire SG19 1RS
T: 01767 691100
E: info@allfill.co.uk www.allfill.co.uk

Optima Packaging Machinery PLC
7 Loader Close, Kings Worthy, Hampshire SO23 7TF
T: 01962 620898 F: +49 (0)791/506-6500
E: info@optima-gb.com
www.optima-gb.com

Rovema Packaging Machines Ltd
8 Merlin Centre, Gatehouse Close,
Aylesbury, Bucks HP19 8DP
T: 01296 310490 F: 01296 483440
E: sales@rovema.co.uk
www.rovema.com

STATEC BINDER GmbH
Industriestrasse 32, 8200 Gleisdorf,
Austria. T: +43 3112 38580-0
E: office@statec-binder.com
www.statec-binder.com

The Food Machinery Company Ltd
Rochester, Kent ME3 8RF
01634 272345
contact@foodmc.com
www.foodmc.co.uk

FILLING: SOLIDS
Holmach Ltd
Process solutions for industry
T: 01780 749097 E: sales@holmach.co.uk
www.holmach.co.uk

Ilapak Ltd
Uxbridge, Middlesex
UB8 2YF
T: 020 8797 2000
E: sales@ilapak.co.uk www.ilapak.com

Optima Packaging Machinery PLC
7 Loader Close, Kings Worthy, Hampshire SO23 7TF
T: 01962 620898 F: +49 (0)791/506-6500
E: info@optima-gb.com
www.optima-gb.com

STATEC BINDER GmbH
Industriestrasse 32, 8200 Gleisdorf,
Austria. T: +43 3112 38580-0
E: office@statec-binder.com
www.statec-binder.com

FILLING: WEIGH
All-Fill International Ltd
5 Gateshead Close, Sunderland Rd,
Sandy, Bedfordshire SG19 1RS
T: 01767 691100
E: info@allfill.co.uk www.allfill.co.uk

AST Ltd
MADE IN GERMANY
multiweigh
Precision in Weighing Technology
T: +44(0)7730 656691
E: wd@multiweighuk.com www.multiweighuk.com

BW Flexible Systems
A Barry-Wehmler Packaging Company
Nottingham, NG9 1PF, United Kingdom
T: 0115 967 8787 E: sales@bwflexiblesystems.com
www.bwflexiblesystems.com

Evolution BPS
T: 01721 724296
E: sales@evolutionbps.co.uk
www.evolutionbps.co.uk

Ilapak Ltd
Uxbridge, Middlesex
UB8 2YF
T: 020 8797 2000
E: sales@ilapak.co.uk www.ilapak.com

Multipond Limited
Genoa Way, High Wycombe, HP11 1NY
T: 01494 471580 F: 01494 533487
E: info@multipond.co.uk www.multipond.com

SP Filling Systems Ltd
Unit 28, Ddole Industrial Estate,
Llandrindod Wells, Powys LD1 6DF
T: 01597 824918 F: 01597 822553
E: sales@sp-filling.co.uk www.sp-filling.co.uk

STATEC BINDER GmbH
Industriestrasse 32, 8200 Gleisdorf,
Austria. T: +43 3112 38580-0
E: office@statec-binder.com
www.statec-binder.com

The Food Machinery Company Ltd
Rochester, Kent ME3 8RF
01634 272345
contact@foodmc.com
www.foodmc.co.uk

HANDLING ROLLS & REELS
Packline Materials Handling
T: 01202 307700 E: info@packline.co.uk
www.packline.co.uk

HEAT SEALERS
Fischbein-Saxon Ltd FISCHBEIN
A DURAVANT COMPANY
T: +44 (0) 844 372 2877
E: sales@fischbein-saxon.co.uk
www.fischbein.com/eastern

MPE UK LIMITED
Whaley Bridge, Derbyshire SK23 7DQ
T: +44 1663 732 700
E: mark@mpe-uk.com
www.mpe-uk.com

RM Sealers Ltd
Valley Farm, Dagnall, Herts HP4 1QR
T: 01442 843387
E: enquiries@rmsealers.co.uk
www.rmsealers.co.uk

Sealpac UK Ltd SEALPAC UK
6 Partners
Units 1-3, The Concept Centre,
Innovation Close, Poole, Dorset BH12 4QD, UK
T: 0845 302 3056 F: 0845 302 3057
E: sales@sealpac-uk.com www.sealpac-uk.com

Shemesh Automation UK Ltd
Berkeley Square, Mayfair,
London W1J 6DB T: +44 207 887 6004
E: SA@shemeshautomation.com
www.shemeshautomation.com

HOT FOIL PRINTERS
Open Date Equipment Ltd
Mitcham, Surrey CR4 4DG
T: 020 8655 4999
E: sales@opendate.co.uk
www.opendate.co.uk

HOT MELT APPLICATION EQUIPMENT
Endoline Machinery Ltd
Biggleswade, SG18 8QB
T: 01767 316422
E: sales@endoline-automation.com
www.endoline-automation.com

Robatech Gluing Technology
Basildon, Essex, SS15 6SW
T: 01268 490035
E: info@robatechgt.com
www.robatechgt.com

Valco Melton UK
Hortonwood 32,
Telford TF1 7YN
T: 01952 677911 F: 01952 677945
E: uk@valcomelton.com www.valcomelton.com

INDUCTION CAP SEALING
Enercon Industries Ltd
62-64 Edison Road, Aylesbury,
Bucks HP19 8UX
T: +44(0)1296 330542 F: +44(0)1296 432098
E: info@enerconind.co.uk www.enerconind.co.uk

INK JET CODERS
ATD Marking Systems
Marley House, The Mill, Great Bowden Road,
Market Harborough, Leicestershire, LE16 7DE
T: 01858 461014 F: 01858 436900
E: mail@atduk.com www.atduk.com

Atwell self-adhesive Labellers
T: 01444 239970
E: sales@atwell-labellers.co.uk www.labeller.co.uk

Open Date Equipment Ltd
Mitcham, Surrey CR4 4DG
T: 020 8655 4999
E: sales@opendate.co.uk
www.opendate.co.uk

Rotech Machines Limited
Hertfordshire AL7 1AJ
T: +44 (0) 1707 393700
E: sales@rotechmachines.com
www.rotechmachines.com

Weber Packaging Solutions Weber
Macmerry Industrial Estate,
Tranent, East Lothian, EH33 1HD
T: 01875 611 111 F: 01875 613 310
E: sales@weber.co.uk www.weber.co.uk

INK JET PRINTERS
ATD Marking Systems
Marley House, The Mill, Great Bowden Road,
Market Harborough, Leicestershire, LE16 7DE
T: 01858 461014 F: 01858 436900
E: mail@atduk.com www.atduk.com

Autopack Ltd
Unit 6, Twyford Court, Rotherwas
Industrial Estate, Hereford HR2 6JR
T: 01432 800 377
E: info@auto-pack.co.uk
www.auto-pack.co.uk

Sojet
www.t-mark.co.uk
email: sales@t-mark.co.uk
call: 0870 803 1877
THERMAL INKJET PRINTERS **T-MARK**

Weber Packaging Solutions Weber
Macmerry Industrial Estate,
Tranent, East Lothian, EH33 1HD
T: 01875 611 111 F: 01875 613 310
E: sales@weber.co.uk www.weber.co.uk

INSPECTION SYSTEMS
Evolution BPS
T: 01721 724296
E: sales@evolutionbps.co.uk
www.evolutionbps.co.uk

Fortress Technology (Europe) Ltd
Banbury, Oxon, OX16 1RH
T: 01295 256266
E: Sales-UK@fortresstechnology.com
www.fortresstechnology.co.uk

IMPERX, Inc.
Florida, 33487, USA
T: (+1)-561-989-0006
E: sales@imperx.com
www.imperx.com

M.D.S. Ltd Metal Detection Services
St. Martins Studios, Greenbank Road,
Sale, Cheshire M33 5PL
T: Sales 0161 286 8755 T: 0161 286 8750
E: sales@mds.org.uk www.mds.org.uk

Nordson (U.K.) Ltd.
25 Faraday Road, Rabans Lane Industrial Area,
Aylesbury, HP19 8RY
T: 01296 610 140 F: 01296 610 175
E: sales@uk.nordson.com
www.nordson.co.uk/adhesives

Scorpion Vision Ltd
118 Gore Road, New Milton,
Hampshire BH25 6SJ
T: 01590 679333
E: sales@scorpion.vision
www.scorpionvision.co.uk



Sealpac UK Ltd **SEALPAC UK**
Units 1-3, The Concept Centre,
Innovation Close, Poole, Dorset BH12 4QD, UK
T: 0845 302 3056 F: 0845 302 3057
E: sales@sealpac-uk.com www.sealpac-uk.com

SEWTEC
AUTOMATION
Automation House, Jane's Hill, Silkwood, Business Park,
Wakefield, West Yorkshire, WF5 9TG
T: 01924 494047 E: sales@sewtec.co.uk www.sewtec.co.uk

Sparc Systems Ltd
Malvern, Worcestershire, WR13 6NP
T: 01684 310000
E: sales@sparc-systems.co.uk
www.sparc-systems.co.uk



Valco Melton UK
Hortonwood 32,
Telford TF1 7YN
T: 01952 677911 F: 01952 677945
E: uk@valcomelton.com www.valcomelton.com



Weber Packaging Solutions **Weber**
Macmerry Industrial Estate,
Tranent, East Lothian, EH33 1HD
T: 01875 611 111 F: 01875 613 310
E: sales@weber.co.uk www.weber.co.uk

LABEL INSPECTION
Domino UK Ltd **DOMINO**
Bar Hill, Cambridge
CB23 8TU
T: 01954 782551 E: enquiries@domino-uk.com
www.domino-uk.com



IMPERX, Inc. **IMPERX**
Florida, 33487, USA
T: (+1) 561-989-0006
E: sales@imperx.com
www.imperx.com

Jenton Dimaco
T: +44 (0)1256 892194
E: sales@jenton.co.uk
www.dimaco.co.uk



Olmec-UK Ltd **Olmec**
Barton-Upon-Humber
DN18 5RL
T: 01652 631960
E: sales@olmec-uk.com www.olmec-uk.com

SEWTEC
AUTOMATION
Automation House, Jane's Hill, Silkwood, Business Park,
Wakefield, West Yorkshire, WF5 9TG
T: 01924 494047 E: sales@sewtec.co.uk www.sewtec.co.uk

Sparc Systems Ltd
Malvern, Worcestershire, WR13 6NP
T: 01684 310000
E: sales@sparc-systems.co.uk
www.sparc-systems.co.uk



LABEL PRINTERS
AstroNova
Product Identification
Maidenhead, Berkshire, SL6 3RT
T: 01628 668836
E: info@QuickLabel.co.uk www.QuickLabel.co.uk

Atwell
self-adhesive Labellers
T: 01444 239970
E: sales@atwell-labelers.co.uk www.labeler.co.uk

Weber Packaging Solutions **Weber**
Macmerry Industrial Estate,
Tranent, East Lothian, EH33 1HD
T: 01875 611 111 F: 01875 613 310
E: sales@weber.co.uk www.weber.co.uk

LABEL PRINTING SERVICE
Atwell
self-adhesive Labellers
T: 01444 239970
E: sales@atwell-labelers.co.uk www.labeler.co.uk

LABELLERS
ALS Advanced Labelling Systems Limited
Unit B, Bandet Way, Thame, Oxon, OX9 3SJ
T: 01844 213177 www.als-uk.com

ALTECH UK Labelling Technologies Ltd
Central Park, Bridgend, South Wales CF31 3RT
T: 0800 612 6205
E: sales@altech-uk.com
www.altech-uk.com



ATD Marking Systems
Marley House, The Mill, Great Bowden Road,
Market Harborough, Leicestershire, LE16 7DE
T: 01858 461014 F: 01858 436900
E: mail@atduk.com www.atduk.com



Atwell
self-adhesive Labellers
T: 01444 239970
E: sales@atwell-labelers.co.uk www.labeler.co.uk

Cap Coder Ltd **CapCoder**
Monument Business Park,
Chalgrove, Oxford, OX44 7RW
T: 01865 891466
E: sales@capcoder.com www.capcoder.com



Evolution BPS **evolution**
T: 01721 724296
E: sales@evolutionbps.co.uk
www.evolutionbps.co.uk



HERMA UK Limited * **HERMA**
The Hollands Centre,
Hollands Road, Haverhill, Suffolk CB9 8PR
T: 01440 763366 E: sales@herma.co.uk
www.herma-labellingmachines.co.uk

Industrial Labelling Systems Ltd
D4 Brookside Business Park, Manchester M24 1GS
T: 0161 655 4846
E: sales@ilsystems.co.uk
www.ilsystems.co.uk



Karmelle Ltd
Unit 17, Queens Mill Industrial Estate,
Queens Mill Lane, Huddersfield HD1 3RR
T: 01484 533356
E: Karmelle@gmail.com www.karmelle.com



KHS UK Limited **KHS UK**
6 Monkspath Business Park,
Highley Road, Shirley, Solihull, B90 4NY
T: 0121 713 6900 F: 0121 713 6935
E: info@khs.com www.khs.com



Penn Packaging Ltd **RENNER**
Harkstead Hall Barn,
Ipswich, Suffolk IP9 1DB
T: 01473 893990 www.penn-packaging.co.uk
E: email@penn-packaging.co.uk

Premier Labellers
British Manufactured Labelling Machinery
T: 01255 553822
E: sales@premierlabellers.co.uk www.premierlabellers.co.uk

Propack Automation Machinery Ltd
10 Hill Wootton Rd, Leek Wootton, Warwicks, CV35 7QL
T: 02476 470074
E: office@propack.co.uk
www.propack.co.uk



Sealpac UK Ltd **SEALPAC UK**
Units 1-3, The Concept Centre,
Innovation Close, Poole, Dorset BH12 4QD, UK
T: 0845 302 3056 F: 0845 302 3057
E: sales@sealpac-uk.com www.sealpac-uk.com

Sessions UK
Unit C1 Ebor Industrial Estate,
Hallfield Road, York YO31 7XD
T: 01904 610613
E: enquiry@sessionsuk.com www.sessionsuk.com



SEWTEC
AUTOMATION
Automation House, Jane's Hill, Silkwood, Business Park,
Wakefield, West Yorkshire, WF5 9TG
T: 01924 494047 E: sales@sewtec.co.uk www.sewtec.co.uk

Shemesh Automation UK Ltd
Berkeley Square, Mayfair,
London W1J 6DB T: +44 207 887 6004
E: SA@shemeshautomation.com
www.shemeshautomation.com

Weber Packaging Solutions **Weber**
Macmerry Industrial Estate,
Tranent, East Lothian, EH33 1HD
T: 01875 611 111 F: 01875 613 310
E: sales@weber.co.uk www.weber.co.uk

LABELLING SOFTWARE
ALS Advanced Labelling Systems Limited
Unit B, Bandet Way, Thame, Oxon, OX9 3SJ
T: 01844 213177 www.als-uk.com

Atwell
self-adhesive Labellers
T: 01444 239970
E: sales@atwell-labelers.co.uk www.labeler.co.uk

SEWTEC
AUTOMATION
Automation House, Jane's Hill, Silkwood, Business Park,
Wakefield, West Yorkshire, WF5 9TG
T: 01924 494047 E: sales@sewtec.co.uk www.sewtec.co.uk

Weber Packaging Solutions **Weber**
Macmerry Industrial Estate,
Tranent, East Lothian, EH33 1HD
T: 01875 611 111 F: 01875 613 310
E: sales@weber.co.uk www.weber.co.uk

LANE DIVIDER/COMBINER
Astec Conveyors
Robian Way, Swadlincote, Derbyshire DE11 9DH
T: 01283 210333 F: 01283 210444
E: Sales@Astecconveyors.com
www.asteccconveyors.com



CKF T: 01452 728753
E: info@ckf.co.uk
THE AUTOMATIC SOLUTION www.ckf.co.uk

Jenton Ariana
T: +44 (0)1256 892194
E: sales@jenton.co.uk
www.jentonariana.co.uk



SEWTEC
AUTOMATION
Automation House, Jane's Hill, Silkwood, Business Park,
Wakefield, West Yorkshire, WF5 9TG
T: 01924 494047 E: sales@sewtec.co.uk www.sewtec.co.uk

LASER CODERS
ATD Marking Systems
Marley House, The Mill, Great Bowden Road,
Market Harborough, Leicestershire, LE16 7DE
T: 01858 461014 F: 01858 436900
E: mail@atduk.com www.atduk.com



Weber Packaging Solutions **Weber**
Macmerry Industrial Estate,
Tranent, East Lothian, EH33 1HD
T: 01875 611 111 F: 01875 613 310
E: sales@weber.co.uk www.weber.co.uk

LEAK TESTING
Ishida Europe Ltd **ISHIDA**
Kettles Wood Drive,
Woodgate Business Park, Birmingham B32 3DB
T: 0121 607 7700 F: 0121 607 7666
E: info@ishidaeurope.com www.ishidaeurope.com

Leybold
Leatherhead Road, Chessington, Surrey, KT9 2QL
T: 01372 737300 E: sales.LN@leybold.com
www.leybold.com

LINEAR VIBRATORS
Riley Automation
E: sales@rileyautomation.com
T: 01332 275850 www.rileyautomation.com

LINERLESS LABELLERS
Atwell
self-adhesive Labellers
T: 01444 239970
E: sales@atwell-labelers.co.uk www.labeler.co.uk

HERMA UK Limited * **HERMA**
The Hollands Centre,
Hollands Road, Haverhill, Suffolk CB9 8PR
T: 01440 763366 E: sales@herma.co.uk
www.herma-labellingmachines.co.uk

Weber Packaging Solutions **Weber**
Macmerry Industrial Estate,
Tranent, East Lothian, EH33 1HD
T: 01875 611 111 F: 01875 613 310
E: sales@weber.co.uk www.weber.co.uk

METAL DETECTION
Fortress Technology (Europe) Ltd
Banbury, Oxon, OX16 1RH
T: 01295 256266
E: Sales-UK@fortresstechnology.com
www.fortresstechnology.co.uk



Goudsmit Magnetic Systems BV **goudsmit**
T: +31 (0)40 2213283
E: info@goudsmit.eu
www.goudsmitmagnets.com



M.D.S. Ltd Metal Detection Services
St. Martins Studios, Greenbank Road,
Sale, Cheshire M33 5PL
T: Sales 0161 286 8755 F: 0161 286 8750
E: sales@mds.org.uk www.mds.org.uk



Mettler-Toledo Safeline
Montford Street, Salford, M50 2XD, UK
T: 0161 848 8636
E: safeline.info@mt.com
www.mt.com/metal-detection-Metal-Detection



Sealpac UK Ltd **SEALPAC UK**
Units 1-3, The Concept Centre,
Innovation Close, Poole, Dorset BH12 4QD, UK
T: 0845 302 3056 F: 0845 302 3057
E: sales@sealpac-uk.com www.sealpac-uk.com

The Food Machinery Company Ltd
Rochester, Kent ME3 8RF
01634 272345
contact@foodmc.com
www.foodmc.co.uk



MODIFIED ATMOSPHERE PACKAGING
BW Flexible Systems
A Barry-Wehmiller Packaging Company
Nottingham, NG9 1PF, United Kingdom
T: 0115 967 8787 E: sales@bwflexiblesystems.com
www.bwflexiblesystems.com

Gainsborough Engineering Company
Long Wood Road, Corringham Road Industrial Estate,
Gainsborough, DN21 1QB
T: 01427 617677
F: 01427 810443
E: sales@gains-eng.co.uk
www.gains-eng.co.uk



Ilapak Ltd **ILAPAK**
Uxbridge, Middlesex
UB8 2YF
T: 020 8797 2000
E: sales@ilapak.co.uk www.ilapak.com



Paramount Packaging Systems **PARAMOUNT**
PACKAGING SYSTEMS LTD
FUJI
T: 01252 815252
E: fuji@paramount-packaging.co.uk
www.paramount-packaging.co.uk

pfm PFM House, 2 Pilgrim Way,
Leeds LS28 6LU
T: +44 (0)113 2393401
E: sales@pfmuk.com
www.pfmuk.com



Reiser UK Ltd **REISER**
The Reiser Building,
Maidstone Rd, Kingston, Milton Keynes, MK10 0BD
T: 01908 585300 F: 01908 585400
E: salesuk@reiser.com www.reiser.com

Sealpac UK Ltd **SEALPAC UK**
Units 1-3, The Concept Centre,
Innovation Close, Poole, Dorset BH12 4QD, UK
T: 0845 302 3056 F: 0845 302 3057
E: sales@sealpac-uk.com www.sealpac-uk.com

MULTIHEAD WEIGHERS
AST Ltd **multiweigh**
MADE IN GERMANY
Precision in Weighing Technology
T: +44(0)7730 656691
E: wd@multiweighuk.com www.multiweighuk.com



BW Flexible Systems
A Barry-Wehmiller Packaging Company
Nottingham, NG9 1PF, United Kingdom
T: 0115 967 8787 E: sales@bwflexiblesystems.com
www.bwflexiblesystems.com

Ilapak Ltd **ILAPAK**
Uxbridge, Middlesex
UB8 2YF
T: 020 8797 2000
E: sales@ilapak.co.uk www.ilapak.com



Ishida Europe Ltd **ISHIDA**
Kettles Wood Drive,
Woodgate Business Park, Birmingham B32 3DB
T: 0121 607 7700 F: 0121 607 7666
E: info@ishidaeurope.com www.ishidaeurope.com

Multipond Limited **(MULTIPOND)**
Genoa Way, High Wycombe, HP11 1NY
T: 01494 471580 F: 01494 533487
E: info@multipond.co.uk www.multipond.com

pfm PFM House, 2 Pilgrim Way,
Leeds LS28 6LU
T: +44 (0)113 2393401
E: sales@pfmuk.com
www.pfmuk.com



Sealpac UK Ltd **SEALPAC UK**
Units 1-3, The Concept Centre,
Innovation Close, Poole, Dorset BH12 4QD, UK
T: 0845 302 3056 F: 0845 302 3057
E: sales@sealpac-uk.com www.sealpac-uk.com

The Food Machinery Company Ltd
Rochester, Kent ME3 8RF
01634 272345
contact@foodmc.com
www.foodmc.co.uk



Yamato
Leeds, LS11 5AL
T: 0113 322 1546
E: sales1@yamatoscale.co.uk
www.yamatoscale.co.uk



MULTIPLE PACKAGING EQUIPMENT
AMP automation
T: +44 1427 611 969
E: sales@ampautomation.co.uk
www.ampautomation.co.uk

AMP automation
T: +44 1427 611 969
E: sales@ampautomation.co.uk
www.ampautomation.co.uk

To advertise contact Robert Beswick T 020 8773 5527 E robert.beswick@ppma.co.uk Packaging Machinery

KHS UK Limited
6 Monkspath Business Park,
Highlands Road, Shirley, Solihull, B90 4NY
T: 0121 713 6900 F: 0121 713 6935
E: info@khs.com www.khs.com

Packline Materials Handling
T: 01202 307700 E: info@packline.co.uk
www.packline.co.uk

PALLET SHRINK WRAPPING MACHINERY

SCM Handling Ltd
Broadgauge Business Park, Taunton,
Somerset, TA4 3RU
T: 01823 431838 F: 01823 430806
E: sales@scmhandling.com www.scmhandling.com

PALLET STRETCH WRAPPING MACHINERY

Aetna UK Limited
Oakley, Bedford, MK43 7TA
T: 01234 825050
E: sales.uk@robopac.com www.aetnagroup.co.uk

Endoline Robotics
T: +44 (0)1767 310581 E: sales@endoline-robotics.com
www.endoline-robotics.com

Yorkshire Packaging Systems Ltd
Woodkirk Freight Terminal, Quarry Lane,
Woodkirk, Dewsbury, West Yorkshire WF12 7JL
T: 01924 441355 F: 01924 440686
E: enquiries@yps.co.uk www.yps.co.uk

PALLETISING

ADPAK 30 YEARS
PACKAGING SYSTEMS & FILMS
T: 01282 601444 E: sales@adpak.co.uk
www.adpakmachinerysystems.com

CKF T: 01452 728753
E: info@ckf.co.uk
THE AUTOMATIC SOLUTION www.ckf.co.uk

Endoline Robotics
T: +44 (0)1767 310581 E: sales@endoline-robotics.com
www.endoline-robotics.com

ETT UK Limited
Beccles, Suffolk, NR34 7TD
T: 01502 470812
E: geoff@ett-uk.com www.ett-uk.com

Evolution BPS
T: 01721 724296
E: sales@evolutionbps.co.uk
www.evolutionbps.co.uk

Fischbein-Saxon Ltd
T: +44 (0) 844 372 2877
E: sales@fischbein-saxon.co.uk
www.fischbein.com/eastern

Goudsmit Magnetic Systems BV
T: +31 (0)40 2213283
E: info@goudsmit.eu
www.goudsmitmagnets.com

Kensal Handling Systems
Kensal House, President Way,
Luton, LU2 9NR
T: +44 (0) 1 582 425 777 F: +44 (0) 1 582 425 776
E: sales@kensal.com www.kensal.com

Mpac Langen
+1 905 670 7200
sales.americas@mpac-group.com
www.mpac-group.com

Nordson (U.K.) Ltd.
25 Faraday Road, Rabans Lane Industrial Area,
Aylesbury, HP19 8RY
T: 01296 610 140 F: 01296 610 175
E: sales@uk.nordson.com
www.nordson.co.uk/adhesives

Ocme UK Ltd
King John Hse, Kingsclere Park,
Kingsclere, Newbury, Berkshire RG20 4SW UK
T: 01635 298171 F: 01635 297936
E: sales.uk@ocme.com www.ocme.com

RAUPACK
Machinery for Packaging and Assembly
105 Newdigate Road, Nottingham, NG16 1HN
T: 0115 875 9846
E: contact@raupack.co.uk www.raupack.co.uk

RMGROUP
E: sales@rmgroupuk.com
www.rmgroupuk.com
T: +44(0)1686 621704

SCM Handling Ltd
Broadgauge Business Park, Taunton,
Somerset, TA4 3RU
T: 01823 431838 F: 01823 430806
E: sales@scmhandling.com www.scmhandling.com

Scott Automation Ltd (Alvey)
T: +44 1925 426 001
E: info@scottautomation.co.uk
www.scottautomation.co.uk

SEWTEC AUTOMATION
Automation House, Jane's Hill, Silkwood, Business Park,
Wakefield, West Yorkshire, WF5 9TG
T: 01924 494047 E: sales@sewtec.co.uk www.sewtec.co.uk

SOCO SYSTEM
SOCO SYSTEM (UK) Ltd
Unit 18, Palmerston Street, Hanley,
Stoke-On-Trent, Staffs. ST1 3EU
T: 01782 274100 F: 01782 272696
E: info@socosystem.co.uk
www.socosystem.com

STATEC BINDER GmbH
Industriestrasse 32, 8200 Gleisdorf,
Austria. T: +43 31 12 38580-0
E: office@statec-binder.com
www.statec-binder.com

Valco Melton UK
Hortonwood 32,
Telford TF1 7YN
T: 01952 677911 F: 01952 677945
E: uk@valcomelton.com www.valcomelton.com

WestRock
Unit 3 Malory Road, Beacon Park, Gorleston,
Great Yarmouth, NR31 7DT, UK T: 01493 257070
E: aps.uk@westrock.com www.westrock.com/automation-uk

PICK & PLACE MACHINES

AMP automation T: +44 1427 611 969
E: sales@ampautomation.co.uk
www.ampautomation.co.uk

CAMA 3 Ltd
Suite 44, Berkeley House,
Hunts Rise, South Marston Park,
Swindon, Wilts, SN3 4TC
T: 01793 831111 F: 01793 831481
E: cama3@camagroup.com www.camagroup.com

Cap Coder Ltd
Monument Business Park,
Chalgrove, Oxford, OX44 7RW
T: 01865 891466
E: sales@capcoder.com www.capcoder.com

CKF T: 01452 728753
E: info@ckf.co.uk
THE AUTOMATIC SOLUTION www.ckf.co.uk

Endoline Machinery Ltd
Biggleswade, SG18 8QB
T: 01767 316422
E: sales@endoline-automation.com
www.endoline-automation.com

ETT UK Limited
Beccles, Suffolk, NR34 7TD
T: 01502 470812
E: geoff@ett-uk.com www.ett-uk.com

FANUC Coventry, CV7 9DR
T: 024 7605 3000
E: marketing@fanuc.co.uk
www.fanuc.eu

GRIPPLE AUTOMATION
info@grippleautomation.com
www.grippleautomation.com T: 0114 2800 830

IXAPACK GLOBAL
T: +33 772 142 856
E: laurent.noiraud@ixapack.com
www.ixapack.com

RMGROUP E: sales@rmgroupuk.com
www.rmgroupuk.com
T: +44(0)1686 621704

SCM Handling Ltd
Broadgauge Business Park, Taunton,
Somerset, TA4 3RU
T: 01823 431838 F: 01823 430806
E: sales@scmhandling.com www.scmhandling.com

Sealpac UK Ltd
Units 1-3, The Concept Centre,
Innovation Close, Poole, Dorset BH12 4QD, UK
T: 0845 302 3056 F: 0845 302 3057
E: sales@sealpac-uk.com www.sealpac-uk.com

SEWTEC AUTOMATION
Automation House, Jane's Hill, Silkwood, Business Park,
Wakefield, West Yorkshire, WF5 9TG
T: 01924 494047 E: sales@sewtec.co.uk www.sewtec.co.uk

Tekpak Automation Ltd (UK)
T: +44 (0)113 3505694
E: sales@tepkak.co.uk
www.tepkak.co.uk

WestRock
Unit 3 Malory Road, Beacon Park, Gorleston,
Great Yarmouth, NR31 7DT, UK T: 01493 257070
E: aps.uk@westrock.com www.westrock.com/automation-uk

PLASMA SURFACE TREATING

Enercon Industries Ltd
62-64 Edison Road, Aylesbury,
Bucks HP19 8UX
T: +44(0)1296 330542 F: +44(0)1296 432098
E: info@enerconind.co.uk www.enerconind.co.uk

POUCH FILL & SEAL MACHINES

Autopack Ltd
Unit 6, Twyford Court, Rotherwas
Industrial Estate, Hereford HR2 6JR
T: 01432 800 377
E: info@auto-pack.co.uk
www.auto-pack.co.uk

Gainsborough Engineering Company
Long Wood Road, Corringham Road Industrial Estate,
Gainsborough, DN21 1QB
T: 01427 617677
F: 01427 810443
E: sales@gains-eng.co.uk
www.gains-eng.co.uk

Ilapak Ltd
Uxbridge, Middlesex
UB8 2YF
T: 020 8797 2000
E: sales@ilapak.co.uk www.ilapak.com

Line Equipment Ltd
Nottingham, NG16 3SU
T: 01773 717007
E: machines@lineequipment.co.uk
www.lineequipment.co.uk

Penn Packaging Ltd
Harkstead Hall Barn,
Ipswich, Suffolk IP9 1DB
T: 01473 893990 www.penn-packaging.co.uk
E: email@penn-packaging.co.uk

RAUPACK
Machinery for Packaging and Assembly
105 Newdigate Road, Nottingham, NG16 1HN
T: 0115 875 9846
E: contact@raupack.co.uk www.raupack.co.uk

Riggs Autopack Ltd
Nelson, Lancs BB9 0HU
T: 01282 440040
E: info@riggsautopack.co.uk
www.riggsautopack.co.uk

Rovema Packaging Machines Ltd
8 Merlin Centre, Gatehouse Close,
Aylesbury, Bucks HP19 8DP
T: 01296 310490 F: 01296 483440
E: sales@rovema.co.uk
www.rovema.com

Shemesh Automation UK Ltd
Berkeley Square, Mayfair,
London W1J 6DB T: +44 207 887 6004
E: SA@shemeshautomation.com
www.shemeshautomation.com

The Food Machinery Company Ltd
Rochester, Kent ME3 8RF
01634 272345
contact@foodmc.com
www.foodmc.co.uk

POUCH SEALERS

RM Sealers Ltd
Valley Farm, Dagnall, Herts HP4 1QR
T: 01442 843387
E: enquiries@rmsealers.co.uk
www.rmsealers.co.uk

PRINT & APPLY LABELLING

ALS Advanced Labelling Systems Limited
Unit B, Bandet Way, Thame, Oxon, OX9 3SJ
T: 01844 213177 www.als-uk.com

Atwell self-adhesive Labellers
T: 01444 239970
E: sales@atwell-labellers.co.uk www.labeller.co.uk

Clearmark Solutions (ICE)
Nottingham NG15 0DP
T: 01159 640144
E: enquiries@uk.interactivecoding.com
www.interactivecoding.co.uk

Cobalt Systems Ltd
Cobalt House, Arden Square,
Electra Way, Crewe, CW1 6HA
T: 01270 539800
E: sales@cobaltis.co.uk www.cobaltis.co.uk

Industrial Labelling Systems Ltd
D4 Brookside Business Park, Manchester M24 1GS
T: 0161 655 4846
E: sales@ilsystems.co.uk
www.ilsystems.co.uk

Karmelle Ltd
Unit 17, Queens Mill Industrial Estate,
Queens Mill Lane, Huddersfield HD1 3RR
T: 01484 533356
E: Karmelle@gmail.com www.karmelle.com

Logopak www.logopak.co.uk
T: 01904 692333

SEWTEC AUTOMATION
Automation House, Jane's Hill, Silkwood, Business Park,
Wakefield, West Yorkshire, WF5 9TG
T: 01924 494047 E: sales@sewtec.co.uk www.sewtec.co.uk

Weber Packaging Solutions
Macmerry Industrial Estate,
Tranent, East Lothian, EH33 1HD
T: 01875 611 111 F: 01875 613 310
E: sales@weber.co.uk www.weber.co.uk

READY MEALS PACKING LINES

AST Ltd MADE IN GERMANY
multiweigh Precision in Weighing Technology
E: wd@multiweighuk.com www.multiweighuk.com

MPE UK LIMITED
Whaley Bridge, Derbyshire SK23 7DQ
T: +44 1663 732 700
E: mark@mpe-uk.com
www.mpe-uk.com

Multipond Limited
Genoa Way, High Wycombe, HP11 1NY
T: 01494 471580 F: 01494 533487
E: info@multipond.co.uk www.multipond.com

Reiser UK Ltd
The Reiser Building,
Maidstone Rd, Kingston, Milton Keynes, MK10 0BD
T: 01908 585300 F: 01908 585400
E: salesuk@reiser.com www.reiser.com

Riggs Autopack Ltd
Nelson, Lancs BB9 0HU
T: 01282 440040
E: info@riggsautopack.co.uk
www.riggsautopack.co.uk

Sealpac UK Ltd
Units 1-3, The Concept Centre,
Innovation Close, Poole, Dorset BH12 4QD, UK
T: 0845 302 3056 F: 0845 302 3057
E: sales@sealpac-uk.com www.sealpac-uk.com

The Food Machinery Company Ltd
Rochester, Kent ME3 8RF
01634 272345
contact@foodmc.com
www.foodmc.co.uk

READY MEALS SLEEVING

KEYMAC 28b Burnett Business Park,
Gypsy Lane, Keynsham,
Bristol BS31 2ED
T: 0117 986 5417
E: sales@keymac.co.uk www.keymac.co.uk

REEL LIFTING EQUIPMENT

Packline *Materials Handling*
T: 01202 307700 E: info@packline.co.uk
www.packline.co.uk

TAWI UK
Unit G, Pentagon Park,
Lodge Farm, Northampton, NN5 7UW
T: 01604 591120
E: sales.uk@tawi.com www.tawi.com

RESEALABLE PACKAGING

Ilapak Ltd
Uxbridge, Middlesex
UB8 2YF
T: 020 8797 2000
E: sales@ilapak.co.uk www.ilapak.com

RFID TRACK AND TRACE SOFTWARE

Sealpac UK Ltd
Units 1-3, The Concept Centre,
Innovation Close, Poole, Dorset BH12 4QD, UK
T: 0845 302 3056 F: 0845 302 3057
E: sales@sealpac-uk.com www.sealpac-uk.com

SEWTEC
AUTOMATION
Automation House, Jane's Hill, Silkwood, Business Park,
Wakefield, West Yorkshire, WF5 9TG
T: 01924 494047 E: sales@sewtec.co.uk www.sewtec.co.uk

RINSERS AIR/ OR PRODUCT

Autopack Ltd
Unit 6, Twyford Court, Rotherwas
Industrial Estate, Hereford HR2 6JR
T: 01432 800 377
E: info@auto-pack.co.uk
www.auto-pack.co.uk

Holmach Ltd
T: 01780 749097 E: sales@holmach.co.uk
www.holmach.co.uk

ROBOTIC HANDLING SYSTEMS

ABB Ltd
Auriga House, Precedent Drive,
Rooksley, Milton Keynes, MK13 8PQ
T: 01908 350300 F: 01908 350301
E: michelle.jocelyn@gb.abb.com
www.abb.com/robotics

ADPAK 30 YEARS IN BUSINESS
PACKAGING SYSTEMS & FILMS
T: 01282 601444 E: sales@adpak.co.uk
www.adpakmachinerysystemsLtd.co.uk

AMP automation
T: +44 1427 611 969
E: sales@ampautomation.co.uk
www.ampautomation.co.uk

BW Integrated Systems
A Barry-Wehmieler Packaging Company
Doncaster, Yorkshire DN11 8EW
T: 01302 711056 E: sales@bwintegratedsystems.com
www.bwintegratedsystems.com

CAMA 3 Ltd
Suite 44, Berkeley House,
Hunts Rise, South Marston Park,
Swindon, Wilts, SN3 4TG
T: 01793 831111 F: 01793 831481
E: cama3@camagroup.com www.camagroup.com

CKF
T: 01452 728753
E: info@ckf.co.uk
THE AUTOMATIC SOLUTION www.ckf.co.uk

CME Ltd
Combe St Nicholas, Somerset, TA20 3NL
T: 01460 269500
E: cme@cme-ltd.com
www.cme-ltd.com

ETT UK Limited
Beccles, Suffolk, NR34 7TD
T: 01502 470812
E: geoff@ett-uk.com
www.ett-uk.com

FANUC Coventry, CV7 9DR
T: 024 7605 3000
E: marketing@fanuc.co.uk
www.fanuc.eu

FlexLink Systems Limited
Milton Keynes, MK14 5BN
T: 01908 327200
E: info.uk@flexlink.com
www.flexlink.com

Goudsmit Magnetic Systems BV
T: +31 (0)40 2213283
E: info@goudsmit.eu
www.goudsmitmagnets.com

GRIPPLE
AUTOMATION
info@gripplautomation.com
www.gripplautomation.com T: 0114 2800 830

Kensal Handling Systems
Kensal House, President Way,
Luton, LU2 9NR
T: +44 (0) 1 582 425 777 F: +44 (0) 1 582 425 776
E: sales@kensal.com www.kensal.com

piab
Oaks Ind. Est., Festival Drive,
Loughborough, LE11 5XN
T: 01509 857010 F: 01509 857011
E: info-uk@piab.com www.piab.com

Quin Systems Ltd
Oaklands Park,
Wokingham, RG41 2FD
T: 0118 977 1077
E: sales@quin.co.uk www.quin.co.uk

RMGROUP
E: sales@rmgroupuk.com
www.rmgroupuk.com
T: +44(0)1686 621704

RNA AUTOMATION LTD
Birmingham B35 7AG
T: 0121 749 2566
E: sales@rnaautomation.com
www.rnaautomation.com

SCM Handling Ltd
Broadgauge Business Park, Taunton,
Somerset, TA4 3RU
T: 01823 431838 F: 01823 430806
E: sales@scmhandling.com www.scmhandling.com

Sealpac UK Ltd
Units 1-3, The Concept Centre,
Innovation Close, Poole, Dorset BH12 4QD, UK
T: 0845 302 3056 F: 0845 302 3057
E: sales@sealpac-uk.com www.sealpac-uk.com

SEWTEC
AUTOMATION
Automation House, Jane's Hill, Silkwood, Business Park,
Wakefield, West Yorkshire, WF5 9TG
T: 01924 494047 E: sales@sewtec.co.uk www.sewtec.co.uk

Tekpak Automation Ltd (UK)
T: +44 (0)113 3505694
E: sales@tepkak.co.uk
www.tepkak.co.uk

The Food Machinery Company Ltd
Rochester, Kent ME3 8RF
01634 272345
contact@foodmc.com
www.foodmc.co.uk

ROBOT INTEGRATORS

AMP automation
T: +44 1427 611 969
E: sales@ampautomation.co.uk
www.ampautomation.co.uk

BW Integrated Systems
A Barry-Wehmieler Packaging Company
Doncaster, Yorkshire DN11 8EW
T: 01302 711056 E: sales@bwintegratedsystems.com
www.bwintegratedsystems.com

CKF
T: 01452 728753
E: info@ckf.co.uk
THE AUTOMATIC SOLUTION www.ckf.co.uk

CME Ltd
Combe St Nicholas, Somerset, TA20 3NL
T: 01460 269500
E: cme@cme-ltd.com
www.cme-ltd.com

endoline
ROBOTICS
T: +44 (0)1767 310581 E: sales@endline-robotics.com
www.endline-robotics.com

ETT UK Limited
Beccles, Suffolk, NR34 7TD
T: 01502 470812
E: geoff@ett-uk.com
www.ett-uk.com

RMGROUP
E: sales@rmgroupuk.com
www.rmgroupuk.com
T: +44(0)1686 621704

SEWTEC
AUTOMATION
Automation House, Jane's Hill, Silkwood, Business Park,
Wakefield, West Yorkshire, WF5 9TG
T: 01924 494047 E: sales@sewtec.co.uk www.sewtec.co.uk

The Food Machinery Company Ltd
Rochester, Kent ME3 8RF
01634 272345
contact@foodmc.com
www.foodmc.co.uk

WestRock
Unit 3 Malory Road, Beacon Park, Gorleston,
Great Yarmouth, NR31 7DT, UK T: 01493 257070
E: aps.uk@westrock.com www.westrock.com/automation-uk

ROBOTIC PALLETISERS

ABB Ltd
Auriga House, Precedent Drive,
Rooksley, Milton Keynes, MK13 8PQ
T: 01908 350300 F: 01908 350301
E: michelle.jocelyn@gb.abb.com
www.abb.com/robotics

AMP automation
T: +44 1427 611 969
E: sales@ampautomation.co.uk
www.ampautomation.co.uk

BW Integrated Systems
A Barry-Wehmieler Packaging Company
Doncaster, Yorkshire DN11 8EW
T: 01302 711056 E: sales@bwintegratedsystems.com
www.bwintegratedsystems.com

CKF
T: 01452 728753
E: info@ckf.co.uk
THE AUTOMATIC SOLUTION www.ckf.co.uk

endoline
ROBOTICS
T: +44 (0)1767 310581 E: sales@endline-robotics.com
www.endline-robotics.com

ETT UK Limited
Beccles, Suffolk, NR34 7TD
T: 01502 470812
E: geoff@ett-uk.com
www.ett-uk.com

FANUC Coventry, CV7 9DR
T: 024 7605 3000
E: marketing@fanuc.co.uk
www.fanuc.eu

Fischbein-Saxon Ltd
T: +44 (0) 844 372 2877
E: sales@fischbein-saxon.co.uk
www.fischbein.com/eastern

GRIPPLE
AUTOMATION
info@gripplautomation.com
www.gripplautomation.com T: 0114 2800 830

ixapack GLOBAL
T: +33 772 142 856
E: laurent.noiraud@ixapack.com
www.ixapack.com

Kensal Handling Systems
Kensal House, President Way,
Luton, LU2 9NR
T: +44 (0) 1 582 425 777 F: +44 (0) 1 582 425 776
E: sales@kensal.com www.kensal.com

KHS UK Limited
6 Monkspath Business Park,
Highlands Road, Shirley, Solihull, B90 4NY
T: 0121 713 6900 F: 0121 713 6935
E: info@khs.com www.khs.com

Ocme UK Ltd
King John Hse, Kingsclere Park,
Kingsclere, Newbury, Berkshire RG20 4SW UK
T: 01635 298171 F: 01635 297936
E: sales.uk@ocme.com www.ocme.com

RMGROUP
E: sales@rmgroupuk.com
www.rmgroupuk.com
T: +44(0)1686 621704

SCM Handling Ltd
Broadgauge Business Park, Taunton,
Somerset, TA4 3RU
T: 01823 431838 F: 01823 430806
E: sales@scmhandling.com www.scmhandling.com

Scott Automation Ltd (Alvey)
T: +44 1925 426 001
E: info@scottautomation.co.uk
www.scottautomation.co.uk

SEWTEC
AUTOMATION
Automation House, Jane's Hill, Silkwood, Business Park,
Wakefield, West Yorkshire, WF5 9TG
T: 01924 494047 E: sales@sewtec.co.uk www.sewtec.co.uk

STATEC BINDER GmbH
Industriestrasse 32, 8200 Gleisdorf,
Austria. T: +43 3112 38580-0
E: office@statec-binder.com
www.statec-binder.com

The Food Machinery Company Ltd
Rochester, Kent ME3 8RF
01634 272345
contact@foodmc.com
www.foodmc.co.uk

WestRock
Unit 3 Malory Road, Beacon Park, Gorleston,
Great Yarmouth, NR31 7DT, UK T: 01493 257070
E: aps.uk@westrock.com www.westrock.com/automation-uk

ROBOTS

ABB Ltd
Auriga House, Precedent Drive,
Rooksley, Milton Keynes, MK13 8PQ
T: 01908 350300 F: 01908 350301
E: michelle.jocelyn@gb.abb.com
www.abb.com/robotics

AMP automation
T: +44 1427 611 969
E: sales@ampautomation.co.uk
www.ampautomation.co.uk

CAMA 3 Ltd
Suite 44, Berkeley House,
Hunts Rise, South Marston Park,
Swindon, Wilts, SN3 4TG
T: 01793 831111 F: 01793 831481
E: cama3@camagroup.com www.camagroup.com

CKF
T: 01452 728753
E: info@ckf.co.uk
THE AUTOMATIC SOLUTION www.ckf.co.uk

endoline
ROBOTICS
T: +44 (0)1767 310581 E: sales@endline-robotics.com
www.endline-robotics.com

Kawasaki Robotics
Warrington, WA5 7ZB
T: 01925 713000
E: info@kawasakirobotuk.com
www.kawasakirobot.co.uk

SEWTEC
AUTOMATION
Automation House, Jane's Hill, Silkwood, Business Park,
Wakefield, West Yorkshire, WF5 9TG
T: 01924 494047 E: sales@sewtec.co.uk www.sewtec.co.uk

The Food Machinery Company Ltd
Rochester, Kent ME3 8RF
01634 272345
contact@foodmc.com
www.foodmc.co.uk

TM Robotics Ltd
Welwyn Garden City, Hertfordshire, AL7 1JG
T: 01707 290370
E: sales@tmrobotics.co.uk
www.tmrobotics.co.uk

WestRock
Unit 3 Malory Road, Beacon Park, Gorleston,
Great Yarmouth, NR31 7DT, UK T: 01493 257070
E: aps.uk@westrock.com www.westrock.com/automation-uk

ROBOTS - ARTICULATED ARM

AMP automation
T: +44 1427 611 969
E: sales@ampautomation.co.uk
www.ampautomation.co.uk

FANUC Coventry, CV7 9DR
T: 024 7605 3000
E: marketing@fanuc.co.uk
www.fanuc.eu

Goudsmit Magnetic Systems BV
T: +31 (0)40 2213283
E: info@goudsmit.eu
www.goudsmitmagnets.com

Sealpac UK Ltd
Units 1-3, The Concept Centre,
Innovation Close, Poole, Dorset BH12 4QD, UK
T: 0845 302 3056 F: 0845 302 3057
E: sales@sealpac-uk.com www.sealpac-uk.com

SEWTEC
AUTOMATION
Automation House, Jane's Hill, Silkwood, Business Park,
Wakefield, West Yorkshire, WF5 9TG
T: 01924 494047 E: sales@sewtec.co.uk www.sewtec.co.uk

To advertise contact Robert Beswick **T** 020 8773 5527 **E** robert.beswick@ppma.co.uk **Packaging Machinery**

ROBOTS - CARTESIAN

AMP automation
 T: +44 1427 611 969
 E: sales@ampautomation.co.uk
 www.ampautomation.co.uk

CKF
 T: 01452 728753
 E: info@ckf.co.uk
 THE AUTOMATIC SOLUTION www.ckf.co.uk

SEWTEC AUTOMATION
 Automation House, Jane's Hill, Silkwood, Business Park, Wakefield, West Yorkshire, WF5 9TG
 T: 01924 494047 E: sales@sewtec.co.uk www.sewtec.co.uk

ROBOTS - COLLABORATIVE

ABB Ltd
 Auriga House, Precedent Drive, Rookley, Milton Keynes, MK13 8PQ
 T: 01908 350300 F: 01908 350301
 E: michelle.jocelyn@gb.abb.com
 www.abb.com/robotics

AMP automation
 T: +44 1427 611 969
 E: sales@ampautomation.co.uk
 www.ampautomation.co.uk

FANUC Coventry, CV7 9DR
 T: 024 7605 3000
 E: marketing@fanuc.co.uk
 www.fanuc.eu

piab
 Oaks Ind. Est., Festival Drive, Loughborough, LE11 5XN
 T: 01509 857010 F: 01509 857011
 E: info-uk@piab.com www.piab.com

SEWTEC AUTOMATION
 Automation House, Jane's Hill, Silkwood, Business Park, Wakefield, West Yorkshire, WF5 9TG
 T: 01924 494047 E: sales@sewtec.co.uk www.sewtec.co.uk

ROBOTS - DELTA STYLE

ABB Ltd
 Auriga House, Precedent Drive, Rookley, Milton Keynes, MK13 8PQ
 T: 01908 350300 F: 01908 350301
 E: michelle.jocelyn@gb.abb.com
 www.abb.com/robotics

AMP automation
 T: +44 1427 611 969
 E: sales@ampautomation.co.uk
 www.ampautomation.co.uk

CAMA 3 Ltd
 Suite 44, Berkeley House, Hunts Rise, South Marston Park, Swindon, Wilts, SN3 4TG
 T: 01793 831111 F: 01793 831481
 E: cama3@camagroup.com www.camagroup.com

FANUC Coventry, CV7 9DR
 T: 024 7605 3000
 E: marketing@fanuc.co.uk
 www.fanuc.eu

SEWTEC AUTOMATION
 Automation House, Jane's Hill, Silkwood, Business Park, Wakefield, West Yorkshire, WF5 9TG
 T: 01924 494047 E: sales@sewtec.co.uk www.sewtec.co.uk

WestRock
 Unit 3 Malory Road, Beacon Park, Gorleston, Great Yarmouth, NR31 7DT, UK
 T: 01493 257070
 E: aps.uk@westrock.com www.westrock.com/automation-uk

SACHET MACHINES

Autopack Ltd
 Unit 6, Twyford Court, Rotherwas Industrial Estate, Hereford HR2 6JR
 T: 01432 800 377
 E: info@auto-pack.co.uk
 www.auto-pack.co.uk

Gainsborough Engineering Company
 Long Wood Road, Corringham Road Industrial Estate, Gainsborough, DN21 1QB
 T: 01427 617677
 F: 01427 810443
 E: sales@gains-eng.co.uk
 www.gains-eng.co.uk

Ilapak Ltd
 Uxbridge, Middlesex UB8 2YF
 T: 020 8797 2000
 E: sales@ilapak.co.uk www.ilapak.com

Propack Automation Machinery Ltd
 10 Hill Wootton Rd, Leek Wootton, Warwicks, CV35 7QL
 T: 02476 470074
 E: office@propack.co.uk
 www.propack.co.uk

The Food Machinery Company Ltd
 Rochester, Kent ME3 8RF
 01634 272345
 contact@foodmc.com
 www.foodmc.co.uk

SAFETY GUARDING

Leuze electronic
 the sensor people
 01480 408500 mail@leuze.co.uk www.leuze.co.uk

SEWTEC AUTOMATION
 Automation House, Jane's Hill, Silkwood, Business Park, Wakefield, West Yorkshire, WF5 9TG
 T: 01924 494047 E: sales@sewtec.co.uk www.sewtec.co.uk

SANDWICH PACKING MACHINES

MPE UK LIMITED
 Whaley Bridge, Derbyshire SK23 7DQ
 T: +44 1663 732 700
 E: mark@mpe-uk.com
 www.mpe-uk.com

SEAL TESTING

Ishida Europe Ltd
 Kettles Wood Drive, Woodgate Business Park, Birmingham B32 3DB
 T: 0121 607 7700 F: 0121 607 7666
 E: info@ishidaeurope.com www.ishidaeurope.com

Jenton Ariana
 T: +44 (0)1256 892194
 E: sales@jenton.co.uk
 www.jentonariana.co.uk

Sealpac UK Ltd
 Units 1-3, The Concept Centre, Innovation Close, Poole, Dorset BH12 4QD, UK
 T: 0845 302 3056 F: 0845 302 3057
 E: sales@sealpac-uk.com www.sealpac-uk.com

SENSORS FOR AUTOMATION

Leuze electronic
 the sensor people
 01480 408500 mail@leuze.co.uk www.leuze.co.uk

SICK (UK) LTD
 Waldkirch House, 39 Hedley Rd, St Albans, Herts AL1 5BN
 T: 01727 831121 F: 01727 856767
 E: info@sick.co.uk www.sick.co.uk

SERIALISATION

Olmec-UK Ltd
 Barton-Upon-Humber DN18 5RL
 T: 01652 631960
 E: sales@olmec-uk.com www.olmec-uk.com

SEWTEC AUTOMATION
 Automation House, Jane's Hill, Silkwood, Business Park, Wakefield, West Yorkshire, WF5 9TG
 T: 01924 494047 E: sales@sewtec.co.uk www.sewtec.co.uk

SHRINK SLEEVING

Yorkshire Packaging Systems Ltd
 Woodkirk Freight Terminal, Quarry Lane, Woodkirk, Dewsbury, West Yorkshire WF12 7JJ
 T: 01924 441355 F: 01924 440686
 E: enquiries@yps.co.uk www.yps.co.uk

SHRINK TUNNELS

Yorkshire Packaging Systems Ltd
 Woodkirk Freight Terminal, Quarry Lane, Woodkirk, Dewsbury, West Yorkshire WF12 7JJ
 T: 01924 441355 F: 01924 440686
 E: enquiries@yps.co.uk www.yps.co.uk

SHRINK WRAPPING

ADPAK
 PACKAGING SYSTEMS & FILMS
 T: 01282 601444 E: sales@adpak.co.uk
 www.adpakmachinerysystemsLtd.co.uk

Aetna UK Limited
 Oakley, Bedford, MK43 7TA
 T: 01234 825050
 E: sales.uk@robopac.com www.aetnagroup.co.uk

Ilapak Ltd
 Uxbridge, Middlesex UB8 2YF
 T: 020 8797 2000
 E: sales@ilapak.co.uk www.ilapak.com

KHS UK Limited
 6 Monkspath Business Park, Highlands Road, Shirley, Solihull, B90 4NY
 T: 0121 713 6900 F: 0121 713 6935
 E: info@khs.com www.khs.com

Marden Edwards Shrinkwrap
 Wimborne, Dorset BH21 7SH
 T: 01202 861200
 E: info@meshrinkwrap.com
 www.meshrinkwrap.com

Penn Packaging Ltd
 Harkstead Hall Barn, Ipswich, Suffolk IP9 1DB
 T: 01473 893990 www.penn-packaging.co.uk
 E: email@penn-packaging.co.uk

WestRock
 Unit 3 Malory Road, Beacon Park, Gorleston, Great Yarmouth, NR31 7DT, UK
 T: 01493 257070
 E: aps.uk@westrock.com www.westrock.com/automation-uk

Yorkshire Packaging Systems Ltd
 Woodkirk Freight Terminal, Quarry Lane, Woodkirk, Dewsbury, West Yorkshire WF12 7JJ
 T: 01924 441355 F: 01924 440686
 E: enquiries@yps.co.uk www.yps.co.uk

SKIN PACKAGING

Reiser UK Ltd
 The Reiser Building, Maidstone Rd, Kingston, Milton Keynes, MK10 0BD
 T: 01908 585300 F: 01908 585400
 E: salesuk@reiser.com www.reiser.com

Sealpac UK Ltd
 Units 1-3, The Concept Centre, Innovation Close, Poole, Dorset BH12 4QD, UK
 T: 0845 302 3056 F: 0845 302 3057
 E: sales@sealpac-uk.com www.sealpac-uk.com

SLEEVE FEEDERS

atwell
 self-adhesive Labellers
 T: 01444 239970
 E: sales@atwell-labellers.co.uk www.labeller.co.uk

SLEEVING MACHINES

CAMA 3 Ltd
 Suite 44, Berkeley House, Hunts Rise, South Marston Park, Swindon, Wilts, SN3 4TG
 T: 01793 831111 F: 01793 831481
 E: cama3@camagroup.com www.camagroup.com

KEYMAC
 PACKAGING SYSTEMS
 28b Burnett Business Park, Gypsy Lane, Keynsham, Bristol BS31 2ED
 T: 0117 986 5417
 E: sales@keymac.co.uk www.keymac.co.uk

Kliklok International Ltd
 Western Drive, Bristol BS14 0AY
 T: Jason.Godwin@syntegon.com
 T: 01275 557639
 www.syntegon.com

SEWTEC AUTOMATION
 Automation House, Jane's Hill, Silkwood, Business Park, Wakefield, West Yorkshire, WF5 9TG
 T: 01924 494047 E: sales@sewtec.co.uk www.sewtec.co.uk

SPECIAL PURPOSE MACHINES

CME Ltd
 Combe St Nicholas, Somerset, TA20 3NL
 T: 01460 269500
 E: cme@cme-ltd.com
 www.cme-ltd.com

GRIFFLE AUTOMATION
 info@grippleautomation.com
 www.grippleautomation.com T: 0114 2800 830

Mpac Lambert Ltd
 +44 (0)1937 832921
 lambert.sales@mpac-group.com
 www.mpac-lambert.com

SEWTEC AUTOMATION
 Automation House, Jane's Hill, Silkwood, Business Park, Wakefield, West Yorkshire, WF5 9TG
 T: 01924 494047 E: sales@sewtec.co.uk www.sewtec.co.uk

SPIRAL CONVEYORS

Astec Conveyors
 Robian Way, Swadlincote, Derbyshire DE11 9DH
 T: 01283 210333 F: 01283 210444
 E: Sales@Astecconveyors.com
 www.astecconveyors.com

CKF
 T: 01452 728753
 E: info@ckf.co.uk
 THE AUTOMATIC SOLUTION www.ckf.co.uk

Kensal Handling Systems
 Kensal House, President Way, Luton, LU2 9NR
 T: +44 (0) 1582 425 777 F: +44 (0) 1582 425 776
 E: sales@kensal.com www.kensal.com

SCM Handling Ltd
 Broadgauge Business Park, Taunton, Somerset, TA4 3RU
 T: 01823 431838 F: 01823 430806
 E: sales@scmhandling.com www.scmhandling.com

STACKING

Jenton Ariana
 T: +44 (0)1256 892194
 E: sales@jenton.co.uk
 www.jentonariana.co.uk

STICK PACK MACHINES

Autopack Ltd
 Unit 6, Twyford Court, Rotherwas Industrial Estate, Hereford HR2 6JR
 T: 01432 800 377
 E: info@auto-pack.co.uk
 www.auto-pack.co.uk

RAUPACK
 Machinery for Packaging and Assembly
 105 Newdigate Road, Nottingham, NG16 1HN
 T: 0115 875 9846
 E: contact@raupack.co.uk www.raupack.co.uk

STITCHERS

Fischbein-Saxon Ltd
 T: +44 (0) 844 372 8277
 E: sales@fischbein-saxon.co.uk
 www.fischbein.com/eastern

STRETCH WRAPPERS

Aetna UK Limited
 Oakley, Bedford, MK43 7TA
 T: 01234 825050
 E: sales.uk@robopac.com www.aetnagroup.co.uk

Yorkshire Packaging Systems Ltd
 Woodkirk Freight Terminal, Quarry Lane, Woodkirk, Dewsbury, West Yorkshire WF12 7JJ
 T: 01924 441355 F: 01924 440686
 E: enquiries@yps.co.uk www.yps.co.uk

TAMPER EVIDENT SLEEVING

Weber Packaging Solutions
 Macmerry Industrial Estate, Tranent, East Lothian, EH33 1HD
 T: 01875 611 111 F: 01875 613 310
 E: sales@weber.co.uk www.weber.co.uk

TEA BAGGING MACHINES

Ilapak Ltd
 Uxbridge, Middlesex UB8 2YF
 T: 020 8797 2000
 E: sales@ilapak.co.uk www.ilapak.com

RAUPACK
 Machinery for Packaging and Assembly
 105 Newdigate Road, Nottingham, NG16 1HN
 T: 0115 875 9846
 E: contact@raupack.co.uk www.raupack.co.uk

SEWTEC AUTOMATION
 Automation House, Jane's Hill, Silkwood, Business Park, Wakefield, West Yorkshire, WF5 9TG
 T: 01924 494047 E: sales@sewtec.co.uk www.sewtec.co.uk

THERMAL PRINTERS

ALS Advanced Labelling Systems Limited
 Unit B, Bandet Way, Thame, Oxon, OX9 3SJ
 T: 01844 213177 www.als-uk.com

ATD Marking Systems
 Marley House, The Mill, Great Bowden Road, Market Harborough, Leicestershire, LE16 7DE
 T: 01858 461014 F: 01858 436900
 E: mail@atduk.com www.atduk.com

Atwell
self-adhesive **Labellers**
T: 01444 239970
E: sales@atwell-labellers.co.uk www.labeller.co.uk

Open Date Equipment Ltd
Mitcham, Surrey CR4 4DG
T: 020 8655 4999
E: sales@opendate.co.uk
www.opendate.co.uk

Weber Packaging Solutions
Macmerry Industrial Estate,
Tranent, East Lothian, EH33 1HD
T: 01875 611 111 F: 01875 613 310
E: sales@weber.co.uk www.weber.co.uk

Bytronic Birmingham, B60 1BL
AUTOMATION T: +44 (0)1564 793174
E: enquiries@bytronic.com
www.bytronic.com

Reiser UK Ltd
The Reiser Building,
Maidstone Rd, Kingston, Milton Keynes, MK10 0BD
T: 01908 585300 F: 01908 585400
E: salesuk@reiser.com www.reiser.com

Sealpac UK Ltd
Units 1-3, The Concept Centre,
Innovation Close, Poole, Dorset BH12 4QD, UK
T: 0845 302 3056 F: 0845 302 3057
E: sales@sealpac-uk.com www.sealpac-uk.com

Olmec-UK Ltd
Barton-Upon-Humber
DN18 5RL
T: 01652 631960
E: sales@olmec-uk.com www.olmec-uk.com

GRAVFIL Precision Automation **DICO**
01795 551 500 • ppm@prec.co.uk
PRECISIONAUTOMATION.CO.UK/PPMA

RAUPACK
Machinery for Packaging and Assembly
105 Newdigate Road, Nottingham, NG16 1HN
T: 0115 875 9846
E: contact@raupack.co.uk www.raupack.co.uk

SEWTEC
AUTOMATION
Automation House, Jane's Hill, Silkwood, Business Park,
Wakefield, West Yorkshire, WF5 9TG
T: 01924 494047 E: sales@sewtec.co.uk www.sewtec.co.uk

MPE UK LIMITED
Whaley Bridge, Derbyshire SK23 7DQ
T: +44 1663 732 700
E: mark@mpe-uk.com
www.mpe-uk.com

Propack Automation Machinery Ltd
10 Hill Wootton Rd, Leek Wootton, Warwick, CV35 7QL
T: 02476 470074
E: office@propack.co.uk
www.propack.co.uk

Reiser UK Ltd
The Reiser Building,
Maidstone Rd, Kingston, Milton Keynes, MK10 0BD
T: 01908 585300 F: 01908 585400
E: salesuk@reiser.com www.reiser.com

Sealpac UK Ltd
Units 1-3, The Concept Centre,
Innovation Close, Poole, Dorset BH12 4QD, UK
T: 0845 302 3056 F: 0845 302 3057
E: sales@sealpac-uk.com www.sealpac-uk.com

SEWTEC
AUTOMATION
Automation House, Jane's Hill, Silkwood, Business Park,
Wakefield, West Yorkshire, WF5 9TG
T: 01924 494047 E: sales@sewtec.co.uk www.sewtec.co.uk

ETT UK Limited
Beccles, Suffolk, NR34 7TD
T: 01502 470812
E: geoff@ett-uk.com
www.ett-uk.com

KHS UK Limited
6 Monkspath Business Park,
Highlands Road, Shirley, Solihull, B90 4NY
T: 0121 713 6900 F: 0121 713 6935
E: info@khs.com www.khs.com

Kliklok International Ltd
Western Drive, Bristol BS14 0AY
E: Jason.Godwin@syntegon.com
T: 01275 557639
www.syntegon.com

SEWTEC
AUTOMATION
Automation House, Jane's Hill, Silkwood, Business Park,
Wakefield, West Yorkshire, WF5 9TG
T: 01924 494047 E: sales@sewtec.co.uk www.sewtec.co.uk

Tekpak Automation Ltd (UK)
T: +44 (0)113 3505694
E: sales@tekpak.co.uk
www.tekpak.co.uk

WestRock
Unit 3 Malory Road, Beacon Park, Gorleston,
Great Yarmouth, NR31 7DT, UK T: 01493 257070
E: aps.uk@westrock.com www.westrock.com/automation-uk

Ishida Europe Ltd
Kettles Wood Drive,
Woodgate Business Park, Birmingham B32 3DB
T: 0121 607 7700 F: 0121 607 7666
E: info@ishidaeurope.com www.ishidaeurope.com

MPE UK LIMITED
Whaley Bridge, Derbyshire SK23 7DQ
T: +44 1663 732 700
E: mark@mpe-uk.com
www.mpe-uk.com

Reiser UK Ltd
The Reiser Building,
Maidstone Rd, Kingston, Milton Keynes, MK10 0BD
T: 01908 585300 F: 01908 585400
E: salesuk@reiser.com www.reiser.com

Sealpac UK Ltd
Units 1-3, The Concept Centre,
Innovation Close, Poole, Dorset BH12 4QD, UK
T: 0845 302 3056 F: 0845 302 3057
E: sales@sealpac-uk.com www.sealpac-uk.com

Evolution BPS
T: 01721 724296
E: sales@evolutionbps.co.uk
www.evolutionbps.co.uk

Optima Packaging Machinery PLC
7 Loader Close, Kings Worthy, Hampshire SO23 7TF
T: 01962 620898 F: +49 (0)791/506-6500
E: info@optima-gb.com
www.optima-gb.com

Reiser UK Ltd
The Reiser Building,
Maidstone Rd, Kingston, Milton Keynes, MK10 0BD
T: 01908 585300 F: 01908 585400
E: salesuk@reiser.com www.reiser.com

The Food Machinery Company Ltd
Rochester, Kent ME3 8RF
01634 272345
contact@foodmc.com
www.foodmc.co.uk

Adelphi Group
Mill Green Road, Haywards Heath,
West Sussex RH16 1XQ
T: 01444 472300
W: www.adelphi.co.uk

Optima Packaging Machinery PLC
7 Loader Close, Kings Worthy, Hampshire SO23 7TF
T: 01962 620898 F: +49 (0)791/506-6500
E: info@optima-gb.com
www.optima-gb.com

Autopack Ltd
Unit 6, Twyford Court, Rotherwas
Industrial Estate, Hereford HR2 6JR
T: 01432 800 377
E: info@auto-pack.co.uk
www.auto-pack.co.uk

Optima Packaging Machinery PLC
7 Loader Close, Kings Worthy, Hampshire SO23 7TF
T: 01962 620898 F: +49 (0)791/506-6500
E: info@optima-gb.com
www.optima-gb.com

Propack Automation Machinery Ltd
10 Hill Wootton Rd, Leek Wootton, Warwick, CV35 7QL
T: 02476 470074
E: office@propack.co.uk
www.propack.co.uk

SEWTEC
AUTOMATION
Automation House, Jane's Hill, Silkwood, Business Park,
Wakefield, West Yorkshire, WF5 9TG
T: 01924 494047 E: sales@sewtec.co.uk www.sewtec.co.uk

Coperion K-Tron GB
4 Acom Business Park, Stockport, Cheshire, SK4 1AS
T: 0161 209 4810
E: ckb@coperionktron.com
www.coperion.com

piab
Oaks Ind. Est., Festival Drive,
Loughborough, LE11 5XN
T: 01509 857010 F: 01509 857011
E: info-uk@piab.com www.piab.com

VACUUM CUPS
piab
Oaks Ind. Est., Festival Drive,
Loughborough, LE11 5XN
T: 01509 857010 F: 01509 857011
E: info-uk@piab.com www.piab.com

VACUUM LIFTING EQUIPMENT
JOULIN (UK)
T: 0191 265 9151
E: joulinuk@joulin.com
www.joulin.com

Packline Materials Handling
T: 01202 307700 E: info@packline.co.uk
www.packline.co.uk

piab
Oaks Ind. Est., Festival Drive,
Loughborough, LE11 5XN
T: 01509 857010 F: 01509 857011
E: info-uk@piab.com www.piab.com

Reiser UK Ltd
The Reiser Building,
Maidstone Rd, Kingston, Milton Keynes, MK10 0BD
T: 01908 585300 F: 01908 585400
E: salesuk@reiser.com www.reiser.com

Leybold
Leatherhead Road, Chessington, Surrey, KT9 2QL
T: 01372 737300 E: sales.LN@leybold.com
www.leybold.com

piab
Oaks Ind. Est., Festival Drive,
Loughborough, LE11 5XN
T: 01509 857010 F: 01509 857011
E: info-uk@piab.com www.piab.com

Coperion K-Tron GB
4 Acom Business Park, Stockport, Cheshire, SK4 1AS
T: 0161 209 4810
E: ckb@coperionktron.com
www.coperion.com

piab
Oaks Ind. Est., Festival Drive,
Loughborough, LE11 5XN
T: 01509 857010 F: 01509 857011
E: info-uk@piab.com www.piab.com

SEWTEC
AUTOMATION
Automation House, Jane's Hill, Silkwood, Business Park,
Wakefield, West Yorkshire, WF5 9TG
T: 01924 494047 E: sales@sewtec.co.uk www.sewtec.co.uk

Weber Packaging Solutions
Macmerry Industrial Estate,
Tranent, East Lothian, EH33 1HD
T: 01875 611 111 F: 01875 613 310
E: sales@weber.co.uk www.weber.co.uk

PARAMOUNT PACKAGING SYSTEMS LTD
Paramount Packaging Systems
T: 01252 815252
E: fuji@paramount-packaging.co.uk
www.paramount-packaging.co.uk

Riley Automation
E: sales@rileyautomation.com
T: 01332 275850 www.rileyautomation.com

RNA AUTOMATION LTD
Birmingham B35 7AG
T: 0121 749 2566
E: sales@mnaautomation.com
www.mnaautomation.com

TM Robotics Ltd
Welwyn Garden City, Hertfordshire, AL7 1JG
T: 01707 290370
E: sales@tmrobotics.co.uk
www.tmrobotics.co.uk

Sealpac UK Ltd
Units 1-3, The Concept Centre,
Innovation Close, Poole, Dorset BH12 4QD, UK
T: 0845 302 3056 F: 0845 302 3057
E: sales@sealpac-uk.com www.sealpac-uk.com

The Food Machinery Company Ltd
Rochester, Kent ME3 8RF
01634 272345
contact@foodmc.com
www.foodmc.co.uk

VIBRATORY WEIGHERS
Multipond Limited
Genoa Way, High Wycombe, HP11 1NY
T: 01494 471580 F: 01494 533487
E: info@multipond.co.uk www.multipond.com

Sealpac UK Ltd
Units 1-3, The Concept Centre,
Innovation Close, Poole, Dorset BH12 4QD, UK
T: 0845 302 3056 F: 0845 302 3057
E: sales@sealpac-uk.com www.sealpac-uk.com

Allied Vision
T: 01428 748874 M: 0753 112211
E: info@alliedvision.com www.alliedvision.com

ALRAD IMAGING
Newbury, Berkshire RG14 2NS
T: 01635 30345
E: sales@alrad.co.uk www.alrad.co.uk
Alrad Imaging is a trading division of Alrad Instruments Ltd.

IDS
Landmark House, Station Road,
Hook, RG27 9HA, United Kingdom
T: 01256 962910
E: uksales@ids-imaging.com www.ids-imaging.com

IMPERX, Inc.
Florida, 33487, USA
T: (+1)-561-989-0006
E: sales@imperx.com
www.imperx.com

MultiPix imaging
Petersfield, Hampshire GU32 3QF
T: 01730 233332
E: sales@multipix.com www.multipix.com

Scorpion Vision Ltd
118 Gore Road, New Milton,
Hampshire BH25 6SJ
T: 01590 679333
E: sales@scorpionvision.com
www.scorpionvision.co.uk

IMPERX, Inc.
Florida, 33487, USA
T: (+1)-561-989-0006
E: sales@imperx.com
www.imperx.com

Jenton Dimaco
T: +44 (0)1256 892194
E: sales@jenton.co.uk
www.dimaco.co.uk

Olmec-UK Ltd
Barton-Upon-Humber
DN18 5RL
T: 01652 631960
E: sales@olmec-uk.com www.olmec-uk.com

Scorpion Vision Ltd
118 Gore Road, New Milton,
Hampshire BH25 6SJ
T: 01590 679333
E: sales@scorpionvision.com
www.scorpionvision.co.uk

Sealpac UK Ltd
Units 1-3, The Concept Centre,
Innovation Close, Poole, Dorset BH12 4QD, UK
T: 0845 302 3056 F: 0845 302 3057
E: sales@sealpac-uk.com www.sealpac-uk.com

SEWTEC
AUTOMATION
Automation House, Jane's Hill, Silkwood, Business Park,
Wakefield, West Yorkshire, WF5 9TG
T: 01924 494047 E: sales@sewtec.co.uk www.sewtec.co.uk

SICK (UK) LTD
Waldkirch House, 39 Hedley Rd,
St Albans, Herts AL1 5BN
T: 01727 831121 F: 01727 856767
E: info@sick.co.uk www.sick.co.uk

Sparc Systems Ltd
Malvern, Worcestershire, WR13 6NP
T: 01684 310000
E: sales@sparc-systems.co.uk
www.sparc-systems.co.uk

Valco Melton UK
Hortonwood 32,
Telford TF1 7YN
T: 01952 677911 F: 01952 677945
E: uk@valcomelton.com www.valcomelton.com

VISION - HIGH SPEED IMAGING

Allied Vision
 T: 01428 748874 M: 0753 1122211
 E: info@alliedvision.com www.alliedvision.com

IMPERX, Inc.
 Florida, 33487, USA
 T: (+1)-561-989-0006
 E: sales@imperx.com www.imperx.com

MultiPix imaging
 Petersfield, Hampshire GU32 3QF
 T: 01730 233332
 E: sales@multipix.com www.multipix.com

Olmec-UK Ltd
 Barton-Upon-Humber DN18 5RL
 T: 01652 631960
 E: sales@olmec-uk.com www.olmec-uk.com

Scorpion Vision Ltd
 118 Gore Road, New Milton, Hampshire BH25 6SJ
 T: 01590 679333
 E: sales@scorpion.vision www.scorpionvision.co.uk

SEWTEC AUTOMATION
 Automation House, Jane's Hill, Silkwood, Business Park, Wakefield, West Yorkshire, WF5 9TG
 T: 01924 494047 E: sales@sewtec.co.uk www.sewtec.co.uk

SICK (UK) LTD
 Waldkirch House, 39 Hedley Rd, St Albans, Herts AL1 5BN
 T: 01727 831121 F: 01727 856767
 E: info@sick.co.uk www.sick.co.uk

VISION INSPECTION

Allied Vision
 T: 01428 748874 M: 0753 1122211
 E: info@alliedvision.com www.alliedvision.com

Alrad Imaging
 Newbury, Berkshire RG14 2NS
 T: 01635 30345
 E: sales@alrad.co.uk www.alrad.co.uk
 Alrad Imaging is a trading division of Alrad Instruments Ltd.

IMPERX, Inc.
 Florida, 33487, USA
 T: (+1)-561-989-0006
 E: sales@imperx.com www.imperx.com

MultiPix imaging
 Petersfield, Hampshire GU32 3QF
 T: 01730 233332
 E: sales@multipix.com www.multipix.com

Olmec-UK Ltd
 Barton-Upon-Humber DN18 5RL
 T: 01652 631960
 E: sales@olmec-uk.com www.olmec-uk.com

RNA AUTOMATION LTD
 Birmingham B35 7AG
 T: 0121 749 2566
 E: sales@rnaautomation.com www.rnaautomation.com

Scorpion Vision Ltd
 118 Gore Road, New Milton, Hampshire BH25 6SJ
 T: 01590 679333
 E: sales@scorpion.vision www.scorpionvision.co.uk

SEWTEC AUTOMATION
 Automation House, Jane's Hill, Silkwood, Business Park, Wakefield, West Yorkshire, WF5 9TG
 T: 01924 494047 E: sales@sewtec.co.uk www.sewtec.co.uk

SICK (UK) LTD
 Waldkirch House, 39 Hedley Rd, St Albans, Herts AL1 5BN
 T: 01727 831121 F: 01727 856767
 E: info@sick.co.uk www.sick.co.uk

Sparc Systems Ltd
 Malvern, Worcestershire, WR13 6NP
 T: 01684 310000
 E: sales@sparc-systems.co.uk www.sparc-systems.co.uk

Valco Melton UK
 Hortonwood 32, Telford TF1 7YN
 T: 01952 677911 F: 01952 677945
 E: uk@valcomelton.com www.valcomelton.com

Weber Packaging Solutions
 Macmerry Industrial Estate, Tranent, East Lothian, EH33 1HD
 T: 01875 611 111 F: 01875 613 310
 E: sales@weber.co.uk www.weber.co.uk

VISION - LINE SCAN TECHNOLOGY

Alrad Imaging
 Newbury, Berkshire RG14 2NS
 T: 01635 30345
 E: sales@alrad.co.uk www.alrad.co.uk
 Alrad Imaging is a trading division of Alrad Instruments Ltd.

IDS
 Landmark House, Station Road, Hook, RG27 9HA, United Kingdom
 T: 01256 962910
 E: uksales@ids-imaging.com www.ids-imaging.com

Scorpion Vision Ltd
 118 Gore Road, New Milton, Hampshire BH25 6SJ
 T: 01590 679333
 E: sales@scorpion.vision www.scorpionvision.co.uk

SEWTEC AUTOMATION
 Automation House, Jane's Hill, Silkwood, Business Park, Wakefield, West Yorkshire, WF5 9TG
 T: 01924 494047 E: sales@sewtec.co.uk www.sewtec.co.uk

VISION SYSTEMS

Allied Vision
 T: 01428 748874 M: 0753 1122211
 E: info@alliedvision.com www.alliedvision.com

IMPERX, Inc.
 Florida, 33487, USA
 T: (+1)-561-989-0006
 E: sales@imperx.com www.imperx.com

Leuze electronic
 the sensor people
 01480 408500 mail@leuze.co.uk www.leuze.co.uk

MultiPix imaging
 Petersfield, Hampshire GU32 3QF
 T: 01730 233332
 E: sales@multipix.com www.multipix.com

Scorpion Vision Ltd
 118 Gore Road, New Milton, Hampshire BH25 6SJ
 T: 01590 679333
 E: sales@scorpion.vision www.scorpionvision.co.uk

Sealpac UK Ltd
 Units 1-3, The Concept Centre, Innovation Close, Poole, Dorset BH12 4QD, UK
 T: 0845 302 3056 F: 0845 302 3057
 E: sales@sealpac-uk.com www.sealpac-uk.com

SEWTEC AUTOMATION
 Automation House, Jane's Hill, Silkwood, Business Park, Wakefield, West Yorkshire, WF5 9TG
 T: 01924 494047 E: sales@sewtec.co.uk www.sewtec.co.uk

SICK (UK) LTD
 Waldkirch House, 39 Hedley Rd, St Albans, Herts AL1 5BN
 T: 01727 831121 F: 01727 856767
 E: info@sick.co.uk www.sick.co.uk

Weber Packaging Solutions
 Macmerry Industrial Estate, Tranent, East Lothian, EH33 1HD
 T: 01875 611 111 F: 01875 613 310
 E: sales@weber.co.uk www.weber.co.uk

VISION SYSTEMS - 3D

IDS
 Landmark House, Station Road, Hook, RG27 9HA, United Kingdom
 T: 01256 962910
 E: uksales@ids-imaging.com www.ids-imaging.com

MultiPix imaging
 Petersfield, Hampshire GU32 3QF
 T: 01730 233332
 E: sales@multipix.com www.multipix.com

Olmec-UK Ltd
 Barton-Upon-Humber DN18 5RL
 T: 01652 631960
 E: sales@olmec-uk.com www.olmec-uk.com

Scorpion Vision Ltd
 118 Gore Road, New Milton, Hampshire BH25 6SJ
 T: 01590 679333
 E: sales@scorpion.vision www.scorpionvision.co.uk

SEWTEC AUTOMATION
 Automation House, Jane's Hill, Silkwood, Business Park, Wakefield, West Yorkshire, WF5 9TG
 T: 01924 494047 E: sales@sewtec.co.uk www.sewtec.co.uk

SICK (UK) LTD
 Waldkirch House, 39 Hedley Rd, St Albans, Herts AL1 5BN
 T: 01727 831121 F: 01727 856767
 E: info@sick.co.uk www.sick.co.uk

VISION SYSTEMS INTEGRATOR

Bytronic
 Birmingham, B60 1BL
 T: +44 (0)1564 793174
 E: enquiries@bytronic.com www.bytronic.com

GRIFFLE AUTOMATION
 info@grippleautomation.com
 www.grippleautomation.com T: 0114 2800 830

MultiPix imaging
 Petersfield, Hampshire GU32 3QF
 T: 01730 233332
 E: sales@multipix.com www.multipix.com

Olmec-UK Ltd
 Barton-Upon-Humber DN18 5RL
 T: 01652 631960
 E: sales@olmec-uk.com www.olmec-uk.com

Scorpion Vision Ltd
 118 Gore Road, New Milton, Hampshire BH25 6SJ
 T: 01590 679333
 E: sales@scorpion.vision www.scorpionvision.co.uk

SEWTEC AUTOMATION
 Automation House, Jane's Hill, Silkwood, Business Park, Wakefield, West Yorkshire, WF5 9TG
 T: 01924 494047 E: sales@sewtec.co.uk www.sewtec.co.uk

Weber Packaging Solutions
 Macmerry Industrial Estate, Tranent, East Lothian, EH33 1HD
 T: 01875 611 111 F: 01875 613 310
 E: sales@weber.co.uk www.weber.co.uk

WEIGHING MACHINES

AST Ltd
 MADE IN GERMANY
 Precision in Weighing Technology
 T: +44(0)7730 656691
 E: wd@multiweighuk.com www.multiweighuk.com

Autopack Ltd
 Unit 6, Twyford Court, Rotherwas Industrial Estate, Hereford HR2 6JR
 T: 01432 800 377
 E: info@auto-pack.co.uk www.auto-pack.co.uk

BW Flexible Systems
 A Barry-Wehmillier Packaging Company
 Nottingham, NG9 1PF, United Kingdom
 T: 0115 967 8787 E: sales@bwflexiblesystems.com www.bwflexiblesystems.com

Coperion K-Tron GB
 4 Acorn Business Park, Stockport, Cheshire, SK4 1AS
 T: 0161 209 4810
 E: ckb@coperionktron.com www.coperion.com

Multipond Limited
 Genoa Way, High Wycombe, HP11 1NY
 T: 01494 471580 F: 01494 533487
 E: info@multipond.co.uk www.multipond.com

pfm
 PFM House, 2 Pilgrim Way, Leeds LS28 6LU
 T: +44 (0)113 2393401
 E: sales@pfmuk.com www.pfmuk.com

Sealpac UK Ltd
 Units 1-3, The Concept Centre, Innovation Close, Poole, Dorset BH12 4QD, UK
 T: 0845 302 3056 F: 0845 302 3057
 E: sales@sealpac-uk.com www.sealpac-uk.com

STATEC BINDER GmbH
 Industriestrasse 32, 8200 Gleisdorf, Austria
 T: +43 3112 38580-0
 E: office@statec-binder.com www.statec-binder.com

The Food Machinery Company Ltd
 Rochester, Kent ME3 8RF
 01634 272345
 contact@foodmc.com www.foodmc.co.uk

Weber Packaging Solutions
 Macmerry Industrial Estate, Tranent, East Lothian, EH33 1HD
 T: 01875 611 111 F: 01875 613 310
 E: sales@weber.co.uk www.weber.co.uk

WRAP AROUND PACKERS

ADPAK 30 YEARS
 PACKAGING SYSTEMS & FILMS
 T: 01282 601444 E: sales@adpak.co.uk www.adpakmachinerysystemsLtd.co.uk

CAMA 3 Ltd
 Suite 44, Berkeley House, Hunts Rise, South Marston Park, Swindon, Wiltshire, SN3 4TG
 T: 01793 831111 F: 01793 831481
 E: cama3@camagroup.com www.camagroup.com

ETT UK Limited
 Beccles, Suffolk, NR34 7TD
 T: 01502 470812
 E: geoff@ett-uk.com www.ett-uk.com

ixAPACK GLOBAL
 T: +33 727 142 856
 E: laurent.noiraud@ixapack.com www.ixapack.com

KHS UK Limited
 6 Monkspath Business Park, Highlands Road, Shirley, Solihull, B90 4NY
 T: 0121 713 6900 F: 0121 713 6935
 E: info@khs.com www.khs.com

Penn Packaging Ltd
 Harkstead Hall Barn, Ipswich, Suffolk IP9 1DB
 T: 01473 893990 www.penn-packaging.co.uk
 E: email@penn-packaging.co.uk

Rovema Packaging Machines Ltd
 8 Merlin Centre, Gatehouse Close, Aylesbury, Bucks HP19 8DP
 T: 01296 310490 F: 01296 483440
 E: sales@rovema.co.uk www.rovema.com

WestRock
 Unit 3 Malory Road, Beacon Park, Gorleston, Great Yarmouth, NR31 7DT, UK
 T: 01493 257070
 E: aps.uk@westrock.com www.westrock.com/automation-uk

WRAPPING/OVERWRAPPING

CME Ltd
 Combe St Nicholas, Somerset, TA20 3NL
 T: 01460 269500
 E: cme@cme-ltd.com www.cme-ltd.com

ETT UK Limited
 Beccles, Suffolk, NR34 7TD
 T: 01502 470812
 E: geoff@ett-uk.com www.ett-uk.com

Ilapak Ltd
 Uxbridge, Middlesex UB8 2YF
 T: 020 8797 2000
 E: sales@ilapak.co.uk www.ilapak.com

Marden Edwards Limited
 Wimborne, Dorset BH21 7SH
 T: 01202 861200
 E: info@mardenedwards.com www.mardenedwards.com

Sollas UK Ltd
 Hampshire RG28 7BB
 T: 01256 896930
 E: sales@sollasuk.com www.sollas.com

Yorkshire Packaging Systems Ltd
 Woodkirk Freight Terminal, Quarry Lane, Woodkirk, Dewsbury, West Yorkshire WF12 7JJ
 T: 01924 441355 F: 01924 440686
 E: enquiries@yps.co.uk www.yps.co.uk

X-RAY INSPECTION SYSTEMS

Anritsu Infvis Ltd
 Unit 3, Scott Road, Luton, LU3 3BF, UK
 T: +44 (0)845 539 9279
 www.anritsu.com/en-GB/infvis

Ishida Europe Ltd
 Kettles Wood Drive, Woodgate Business Park, Birmingham B32 3DB
 T: 0121 607 7700 F: 0121 607 7666
 E: info@ishidaeurope.com www.ishidaeurope.com

Sealpac UK Ltd
 Units 1-3, The Concept Centre, Innovation Close, Poole, Dorset BH12 4QD, UK
 T: 0845 302 3056 F: 0845 302 3057
 E: sales@sealpac-uk.com www.sealpac-uk.com

Sparc Systems Ltd
 Malvern, Worcestershire, WR13 6NP
 T: 01684 310000
 E: sales@sparc-systems.co.uk www.sparc-systems.co.uk

Yamato
 Leeds, LS11 5AL
 T: 0113 322 1546
 E: sales1@yamatoscale.co.uk www.yamatoscale.co.uk



**Dico® Delta Servo
Rotary Capping Machine**
Extended stroke for easy
dip-tube insertion



With a 71 year history in precision packaging, innovation is programmed into the **Dico®** DNA.

Our next-generation **Dico®** machines are built for versatility. Seal your product with push or twist-on closures, pump action or trigger caps.

Visit precisionautomation.co.uk/ppma to see an example specification at an ultra-competitive price:

£99k

Prices held until end of October 2020



GRAVFIL®
LIQUID FILLING

**Gravfil® Excel B
Volumetric filling machine**

Many bespoke options available

Gravfil® created a pioneering filling machine way back in 1929 – the brand has continued to lead from the front ever since.

Our ATEX-rated option is perfect for safe filling of alcohol-based hand sanitisers.

To view an example ATEX-rated filler at this affordable price, please visit: precisionautomation.co.uk/ppma

£79k

Prices held until end of October 2020



CE  **ATEX rated**

For hand sanitiser and other explosive products
Non-ATEX rated option available.

**LOW COST ✦ VERSATILE ✦ SIMPLE TO OPERATE ✦ HIGH OUTPUT ✦ SMALL FOOTPRINT
SIMPLIFIED PRODUCT CHANGE OVER ✦ QUALITY MONITORING SYSTEM ✦ REMOTE SUPPORT**



KEEP BUSINESS FLOWING LEARN MORE ABOUT OUR COMPETITIVE PRICING

 PRECISIONAUTOMATION.CO.UK/PPMA

 PPMA@PREC.CO.UK

 +44 (0)1795 551500